

**AWNING PARTS  
&  
ACCESSORIES**

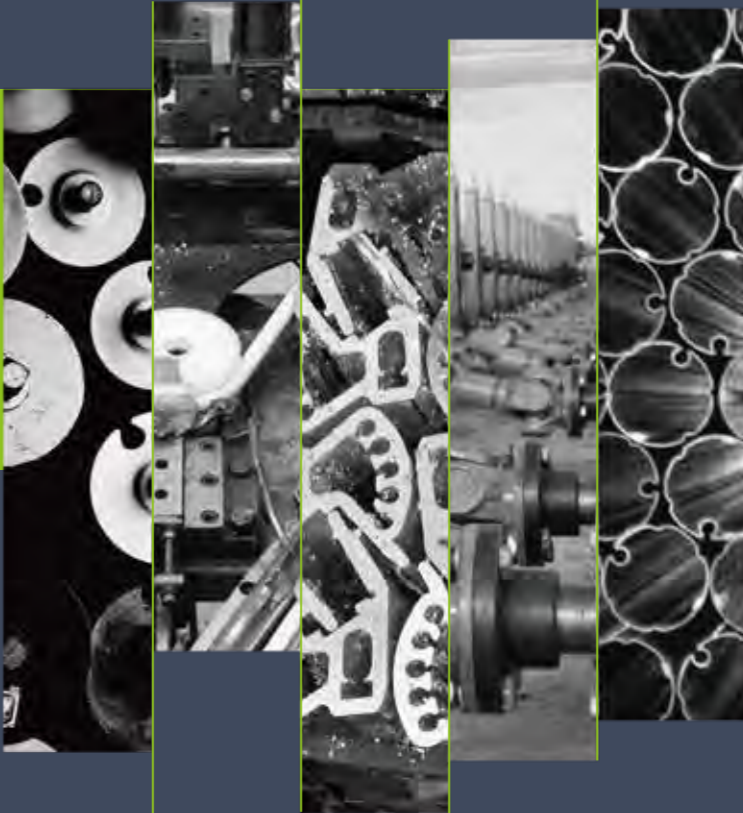



# RESEARCH DESIGN



## RESEARCH & DESIGN

### 研发与设计

During time of products research and design, makes rigorous analysis and comparison base on market demands, comments from customers and sales. The R&D team would make continuous testing and study on latest raw material and innovative technology in order to design more suitable products for meeting customers' demands through a lot of data analysis.



Product design 产品设计



Professional R&D Team 专业认真的设计团队

在产品设计研发的阶段会对市场需求、客户与销售人员对产品的反馈，进行细致的分析与对比。通过大量的数据分析，我们的研发团队会对最新的材料和创新的技术进行不断的测试研究，从而设计出更符合市场与客户需求的产品。



Precise mold opening equipments 专业精准的开模设备

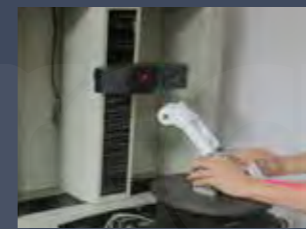



# PRODUCTION

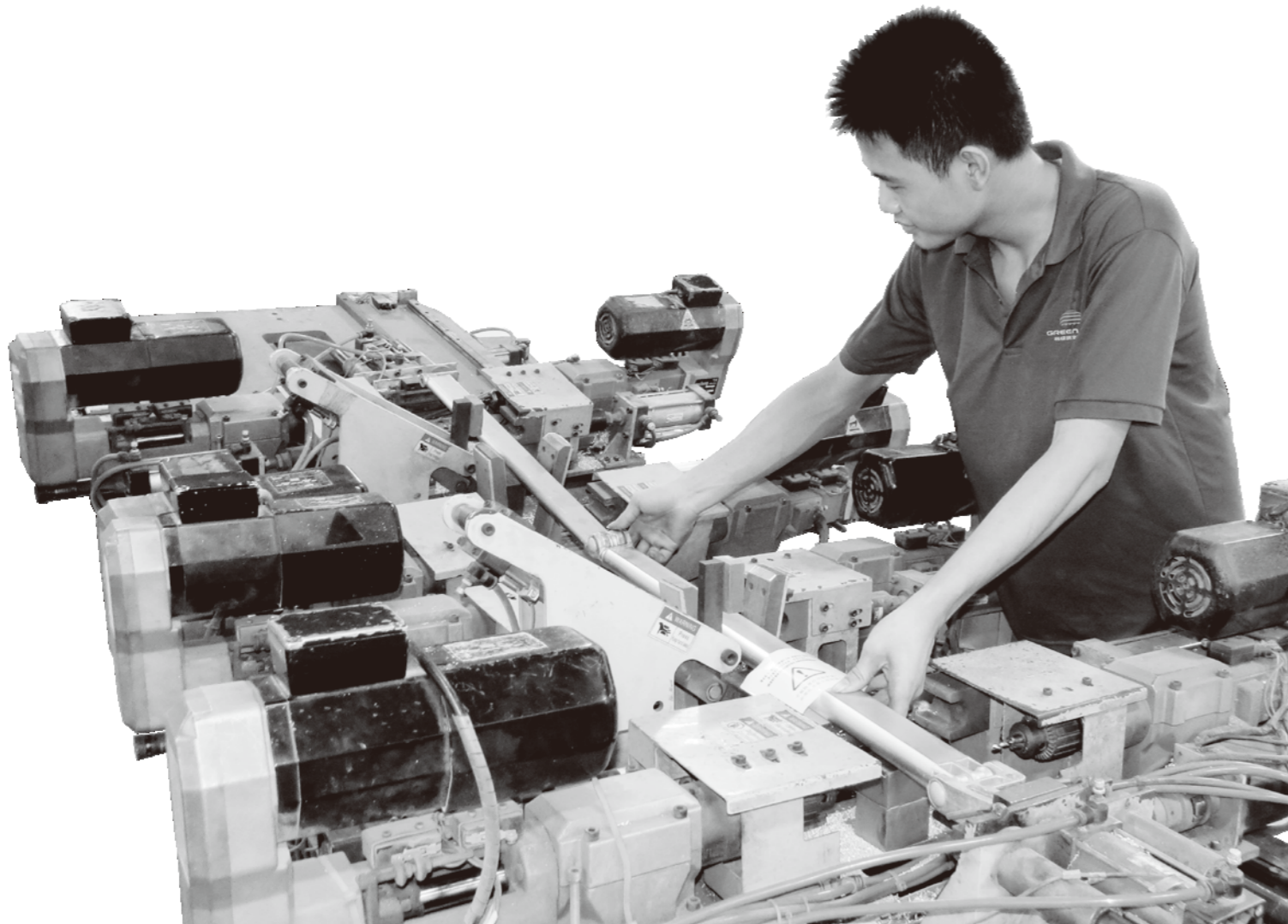

## Complete production equipments 齐全的生产设备



Aluminum production 铝型材生产



Tubes cutting 管材切割



Powder coating 喷涂



Other accessories production 配件组装

## PRODUCTION

### 生产

In order to ensure quality of products, our technical department strictly supervises components production according to precise production procedure through advanced software tools and subsequent processing.

produces galvanized roller tubes with the most professional roller tube machine and staff team. Adopting advance automatic CNC laths, metal stamping equipments and machines. We make precision process on commonly used metal material available.

Meanwhile, production department also equipped with grinding, polishing, painting and fully automatic powder painting machines, making it being able to paint raw material in vivid colors, which greatly meet customized demands.

All products are produced by strict control, assembly and packing.

通过先进的软件工具使模具设计及后续处理，技术部门按照严格的生产流程对产品零件生产进行监控。确保统一的产品生产品质。  
公司设有专业的辊管生产部门，生产车间采用先进的自动数控车床、金属冲压设备等，能对常用的金属原材料进行精密加工。  
同时车间内还设有打磨、抛光、喷漆、全自动化粉末涂料设备，能为各金属材料进行颜色缤纷的涂装，极大地满足不同客户的个性化需求。  
经过严格把控生产出来的零件，由我们专业的工作人员进行组装和包装，最后才能成为格绿朗优质遮阳产品。

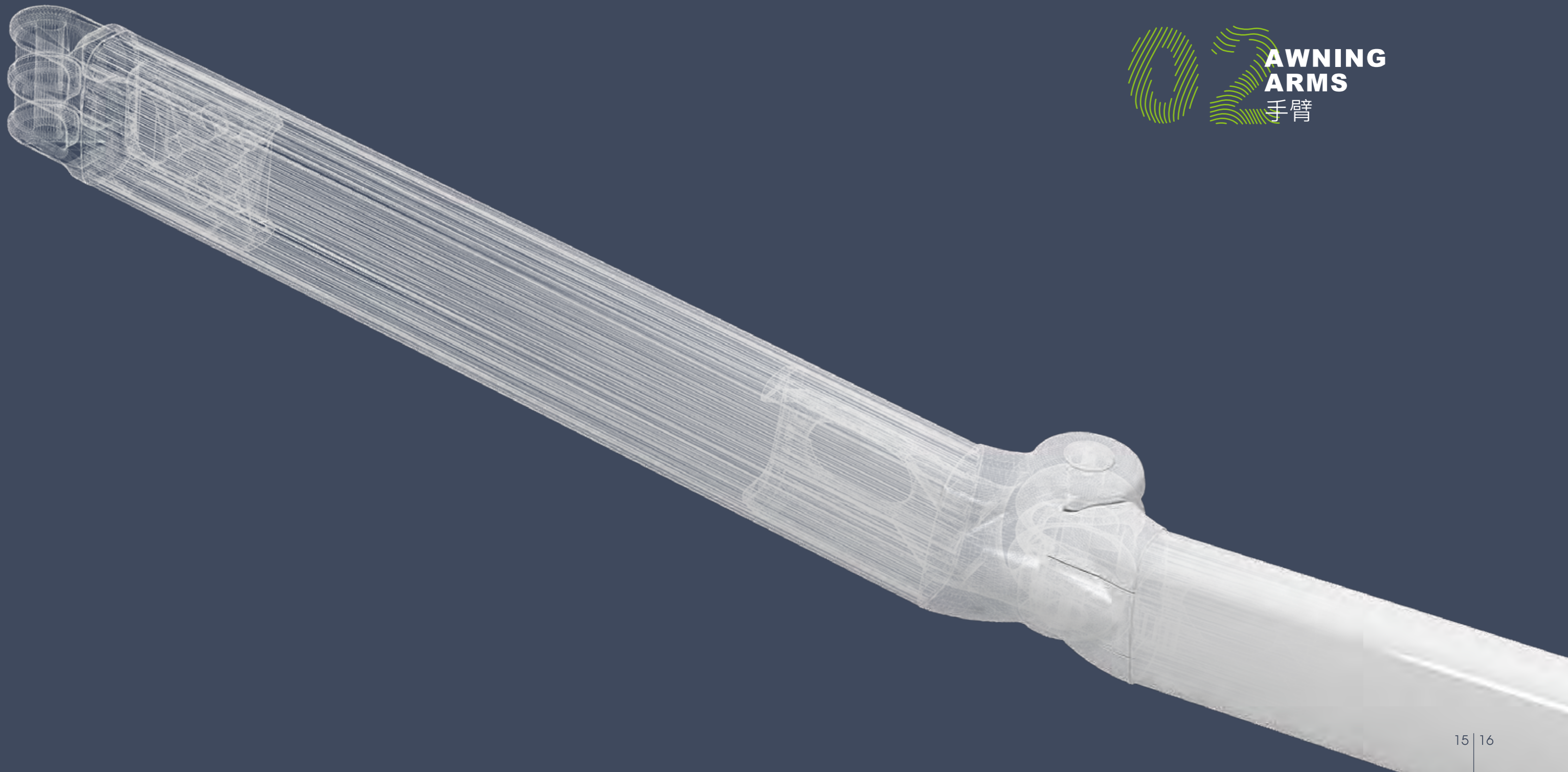

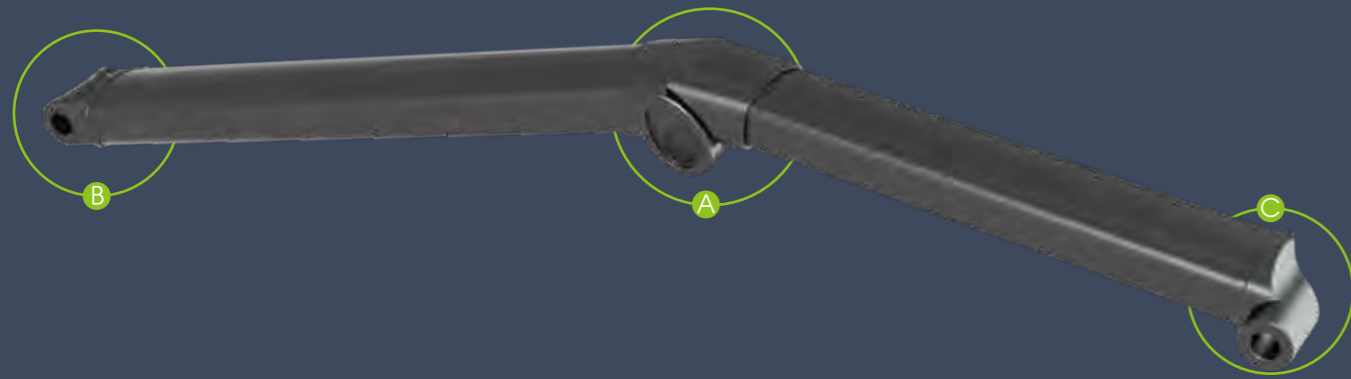

Applicable products  
适用产品

GR-300



GR-350



GR-680

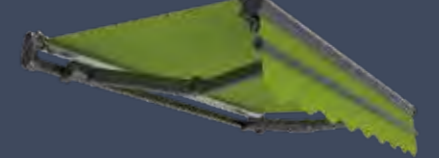

CABLE ARM 300

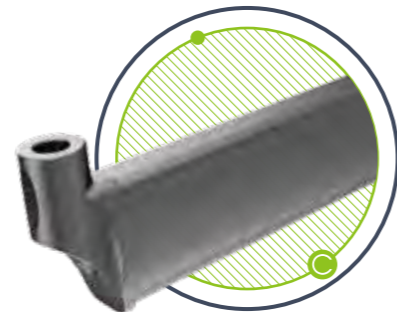
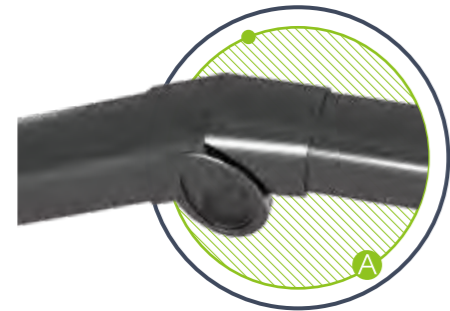

Length specification  
长度规格L1

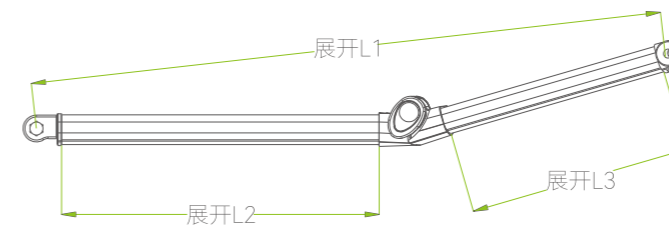

Section of profile  
型材截面

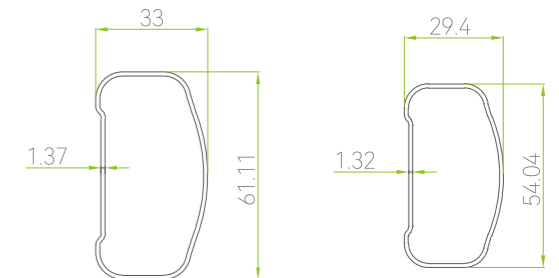

Length specification  
对折规格L4

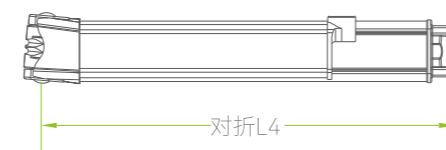

L1	L2	L3	L4
1.5M	79.5CM	59.5CM	85CM
2.0M	109.5CM	79.5CM	111CM
2.5M	124.5CM	109.5CM	130CM
3.0M	159.5CM	129.5CM	165CM



Applicable products  
适用产品

GR-300



GR-350



GR-680

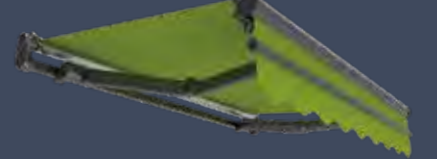

CABLE ARM 350

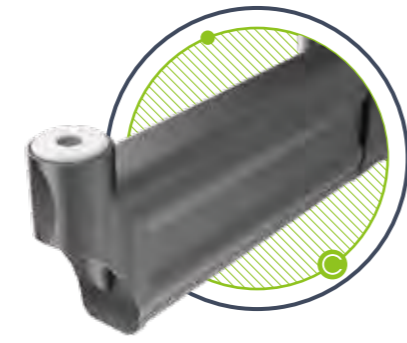
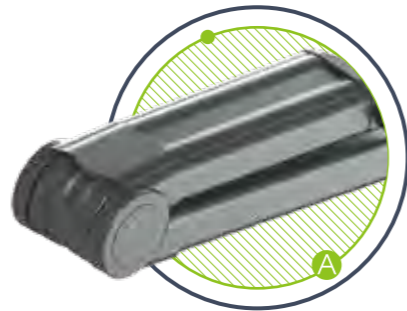
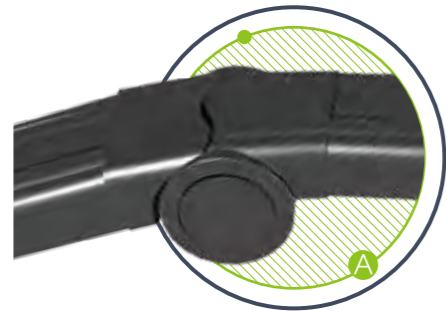

Length specification  
长度规格L1

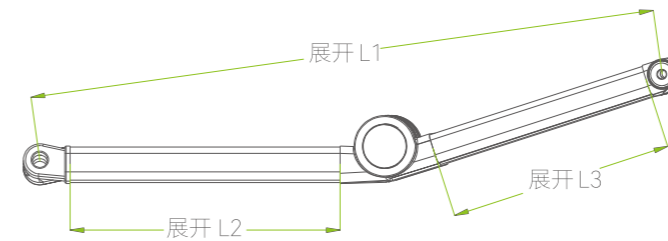

Section of profile  
型材截面

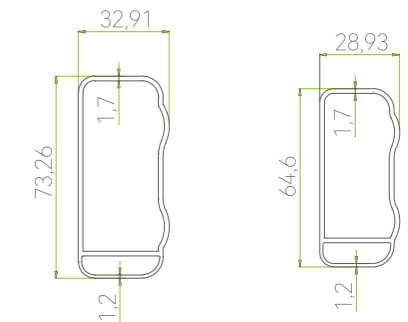

Length specification  
对折规格L4

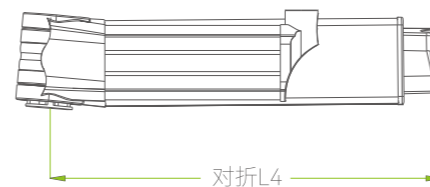

L1	L2	L3	L4
1.5M	74.5CM	59.5CM	82CM
2.0M	99.5CM	84.5CM	107CM
2.5M	124.5CM	109.5CM	132CM
3.0M	149.5CM	134.5CM	157CM
3.5M	174.5CM	159.5CM	182CM

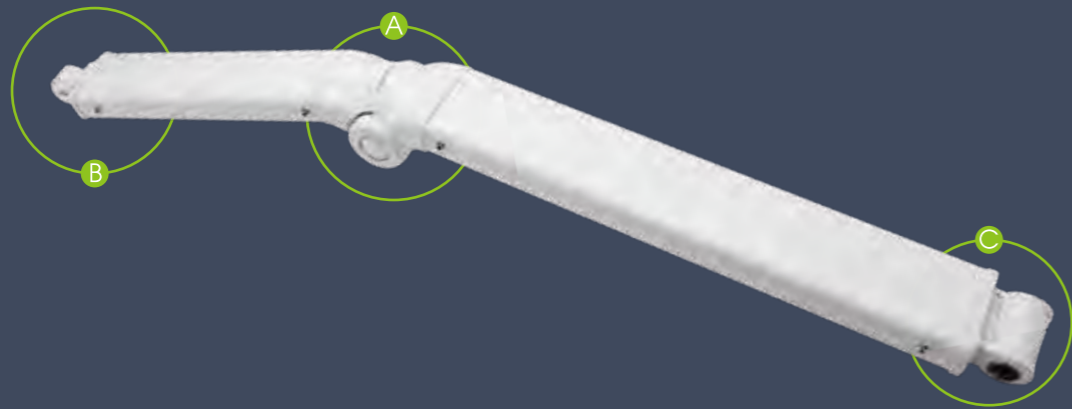

Applicable products  
适用产品

GR-580B2



GR-660



GR-670

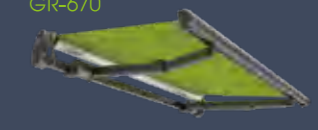

GR-680

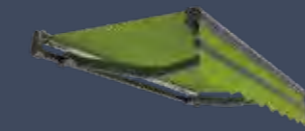

Length specification  
长度规格L1

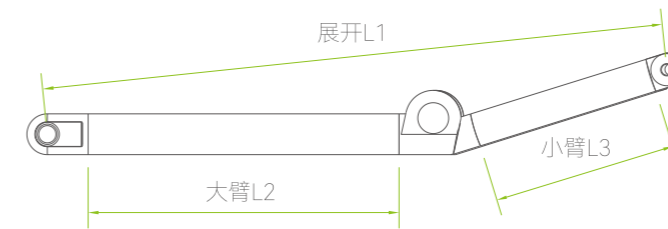

Section of profile  
型材截面

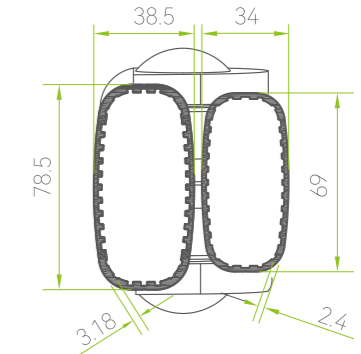

Length specification  
对折规格L4

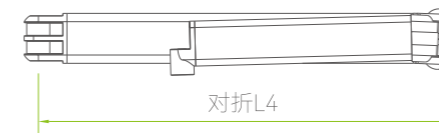

L1	L2	L3	L4
3.0M	149.5CM	134.5CM	162.5CM
3.5M	174.5CM	159.5CM	187.5CM
4.0M	199.5CM	184.5CM	212.5CM
4.5M	224.5CM	209.5CM	237.5CM

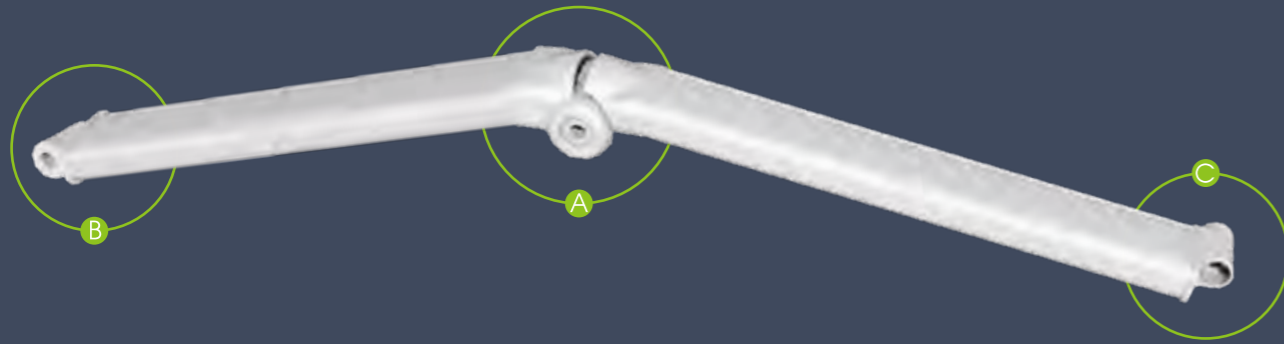

Applicable products  
适用产品

GR-680



GR-830

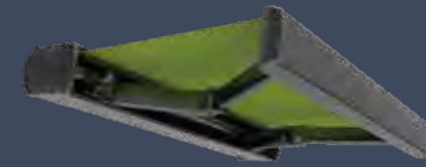

GR-660

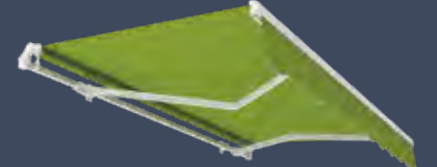

Length specification  
长度规格L1

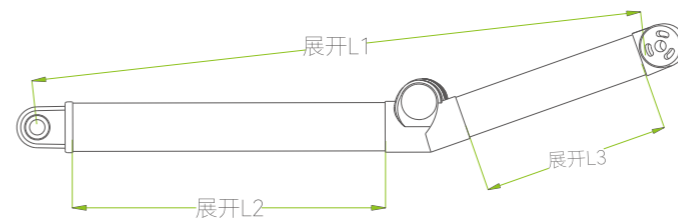

Section of profile  
型材截面

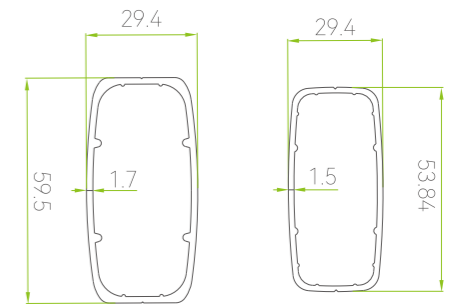

Length specification  
对折规格L4

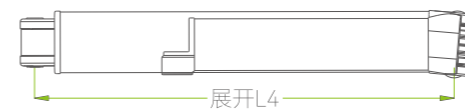

L1	L2	L3	L4
1.5M	74.5CM	59.5CM	86CM
2.0M	99.5CM	84.5CM	111CM
2.5M	124.5CM	109.5CM	136CM
3.0M	149.5CM	134.5CM	161CM
3.5M	174.5CM	159.5CM	186CM

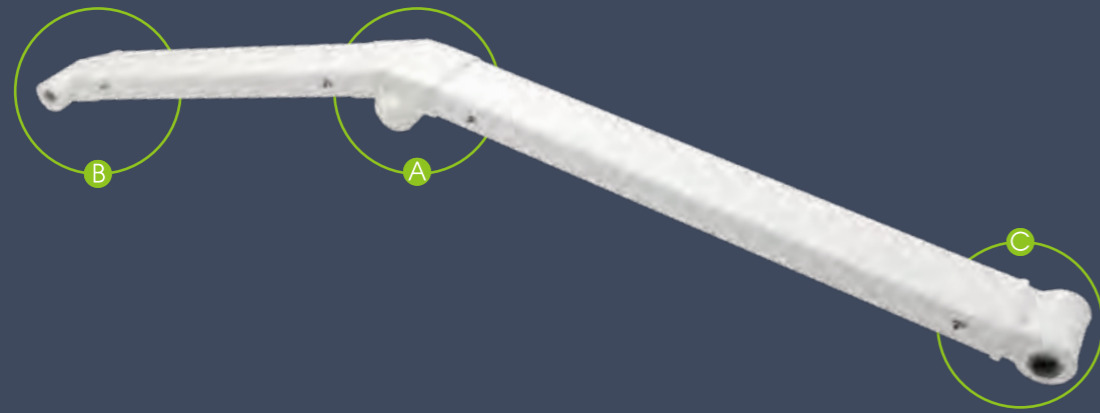

Applicable products  
适用产品



Length specification  
长度规格L1

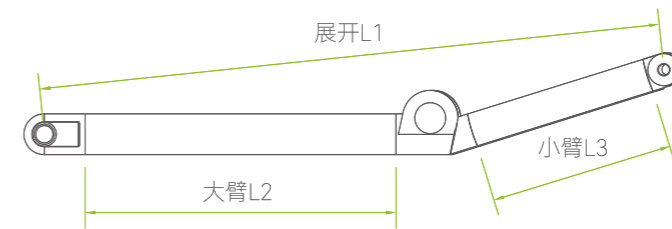

Length specification  
对折规格L4

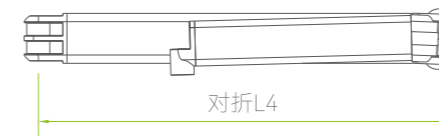

Section of profile  
型材截面

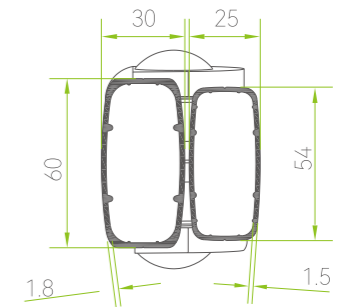

L1	L2	L3	L4
0.8M	39.5CM	24.5CM	50CM
1.0M	49.5CM	34.5CM	60CM
1.5M	74.5CM	59.5CM	85CM
2.0M	99.5CM	84.5CM	110CM
2.5M	124.5CM	109.5CM	135CM
3.0M	149.5CM	134.5CM	160CM
3.5M	174.5CM	159.5CM	185CM

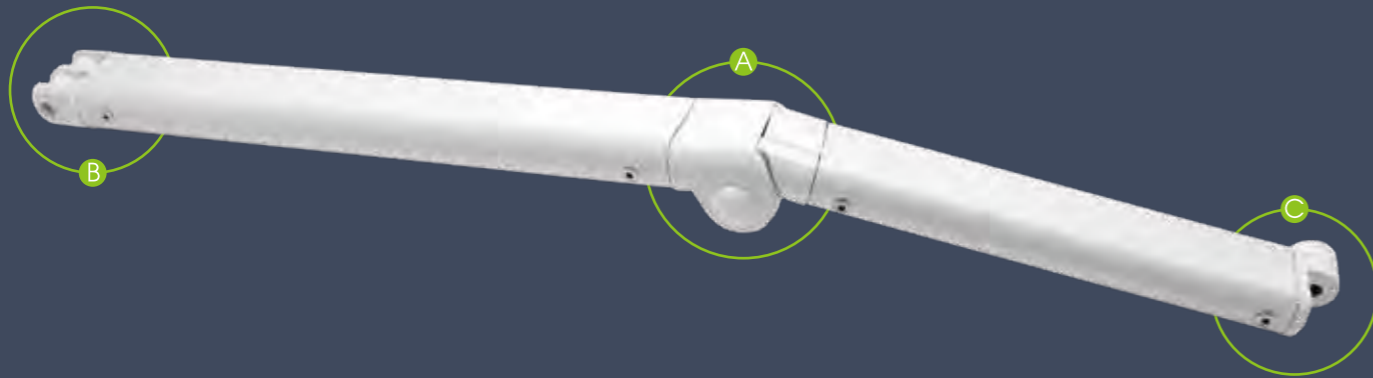

Applicable products  
适用产品

GR-100

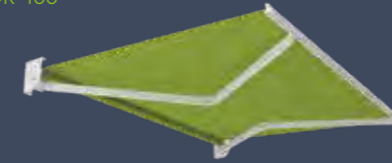

GR-200

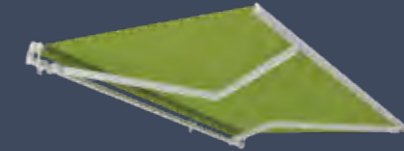

GR-220C

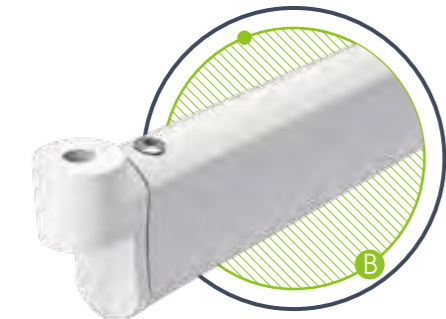
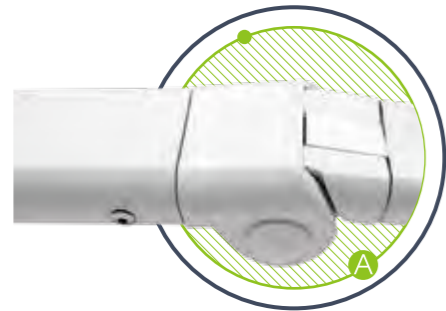
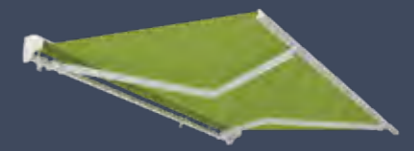

Length specification  
长度规格L1

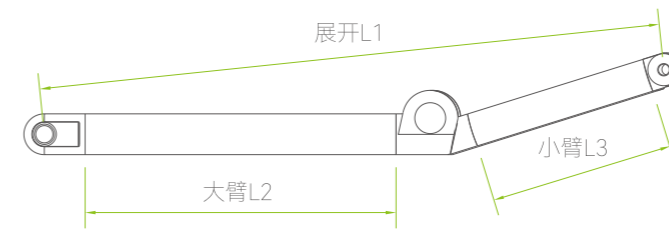

Section of profile  
型材截面

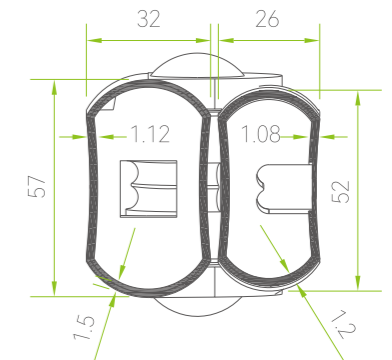

Length specification  
对折规格L4

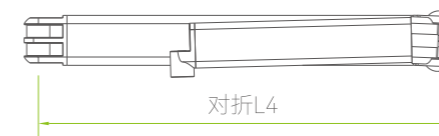

L1	L2	L3	L4
1.5M	74.5CM	64.5CM	84CM
2.0M	99.5CM	89.5CM	109CM
2.5M	124.5CM	114.5CM	134CM
3.0M	149.5CM	139.5CM	159CM



**RETRACTABLE ARM  
AWNINGS SERIES**

曲臂篷系列

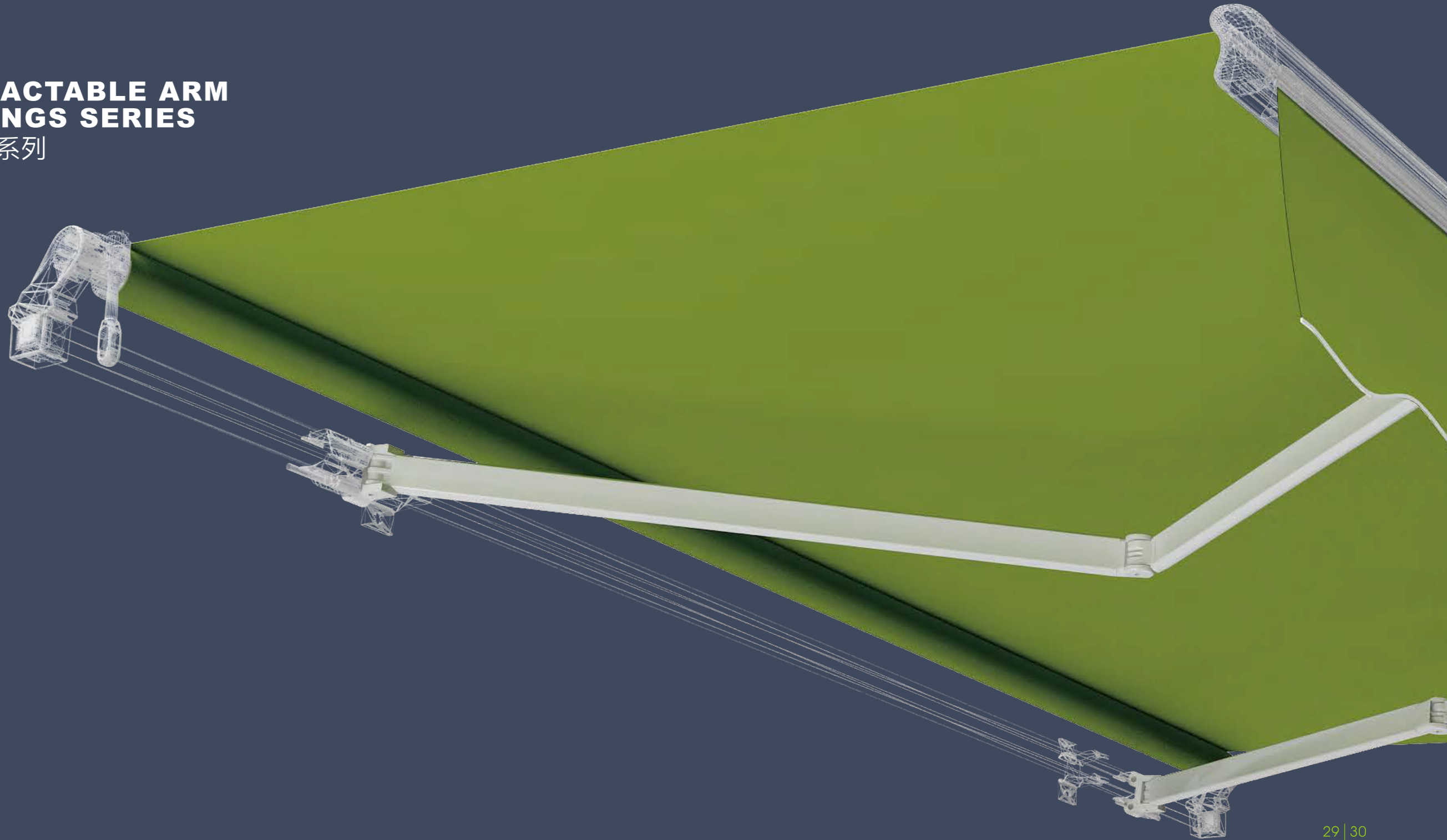

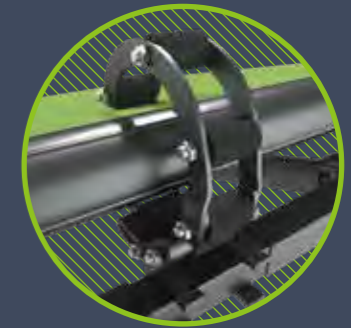
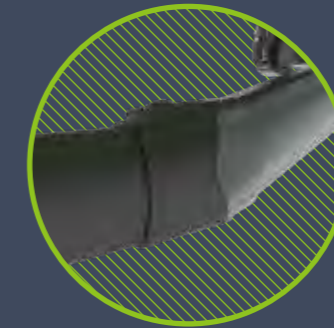
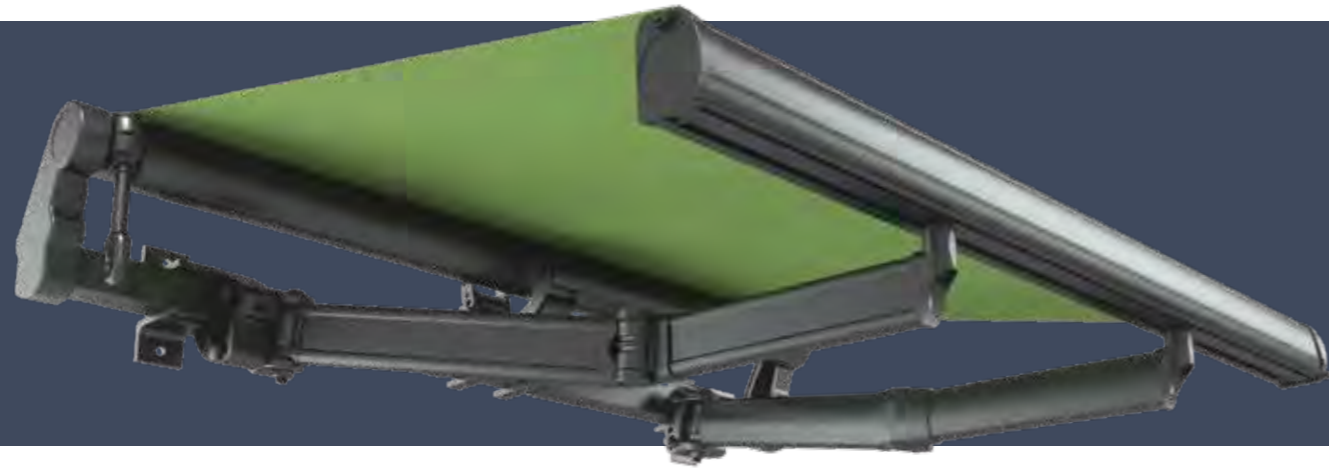

## Description:

High quality aluminum and spring materials, coupled with the unique tubular structure design and double spring structure, make the arm strength great and stable. The aluminum alloy front bar is designed with rain channel which can protect the valance from rain erosion. It can reach a single set of maximum width 6.0m, projection 3.0m. It can be multiple sets of combination splicing to achieve large area sun shading requirements, available with electric remote control device.

Roller	Φ70mm,Φ80mm Steel
Front bar	84x52.6X1.3mm aluminum
Square bar	40x40x1.5mm steel
Arm	61x33x1.37mm/54x29x1.32mm aluminum
Gear Box	1:11
Frame finish	Outdoor Powder Coated
Max size	Width 6.0m, Projection 3.0m
Arms Available	1.5m, 2.0m, 2.5m, 3.0m

## 产品描述:

优质的铝材和弹簧材料，加上独特的管形结构设计和双弹簧结构，使得手臂力量大而稳定，铝合金前杆精心设计的导雨槽，保护荷叶边免受雨水冲蚀。2支手臂即可达到单套最大篷宽6.0m，展幅3.0m，可多套组合拼接实现大面积遮阳需求，可选取电动遥控装置。

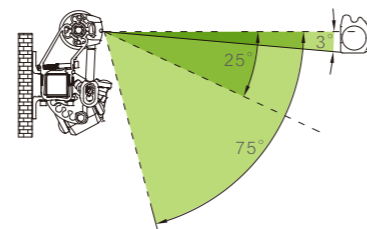
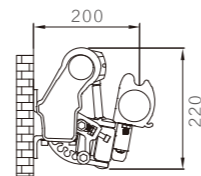

建议 ( Proposal ) : 15°~25°

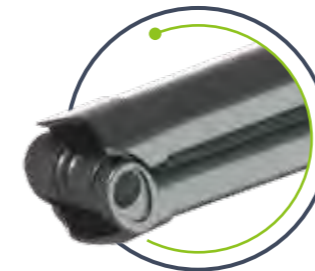

30004 Cable Arm



66012 Square plug



30002 Front bar cap



Central support

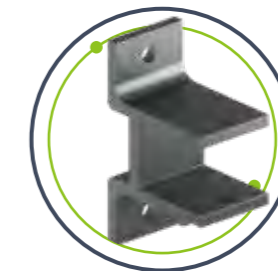

66017 Wall bracket



66011 Gear box 1: 11

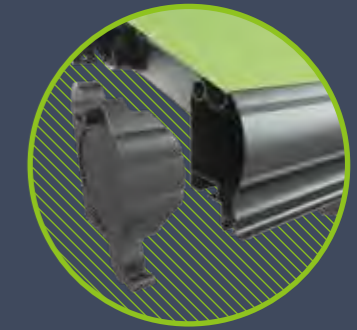
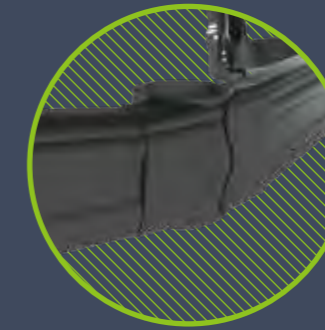

## Description:

High quality aluminum and spring materials, coupled with the unique tubular structure design and double spring structure, make the arm strength great and stable. The aluminum alloy front bar is designed with rain channel which can protect the valance from rain erosion. It can reach a single set of maximum width 6.0m, projection 3.5m. It can be multiple sets of combination splicing to achieve large area sun shading requirements, available with electric remote control device.

Roller	Φ70mm,Φ80mm Steel
Front bar	84x52.6X1.3mm aluminum
Square bar	40x40x1.5mm steel
Arm	73x33x1.7mm/65x29x1.7mm aluminum
Gear Box	1:11
Frame finish	Outdoor Powder Coated
Max size	width 6.0m, projection 3.5m
Arms Available	1.5m, 2.0m, 2.5m, 3.0m, 3.5m

## 产品描述:

优质的铝材和弹簧材料，加上独特的管形结构设计和双弹簧结构，使得手臂力量大而稳定，铝合金前杆精心设计的导雨槽，保护荷叶边免受雨水冲蚀。2支手臂即可达到单套最大篷宽6.0m，展幅3.5m，可多套组合拼接实现大面积遮阳需求，可选取电动遥控装置。

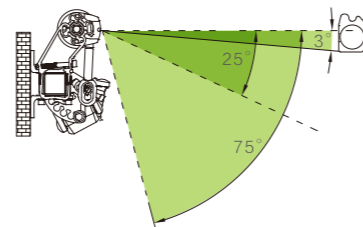
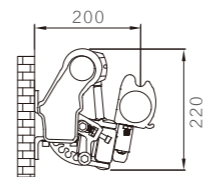

建议 ( Proposal ) : 15°~25°

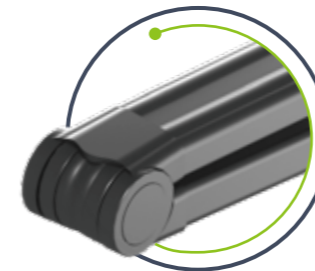

35004 Cable Arm

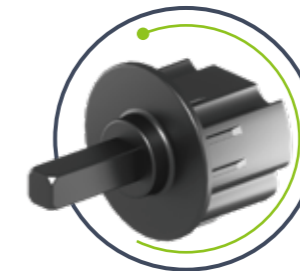

66012 Square plug



35002 Front bar cap



Central support

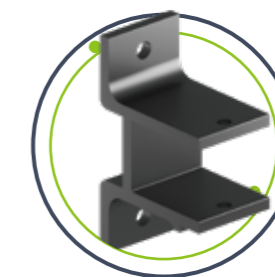

66017 Wall bracket

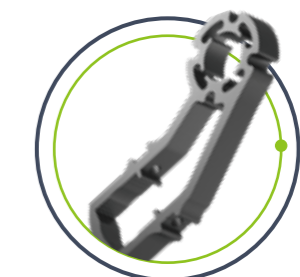

35008 Reel support part

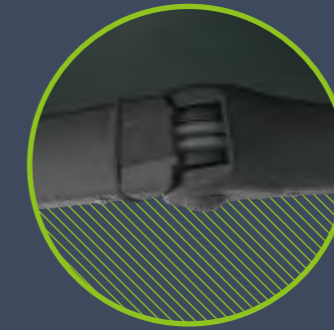
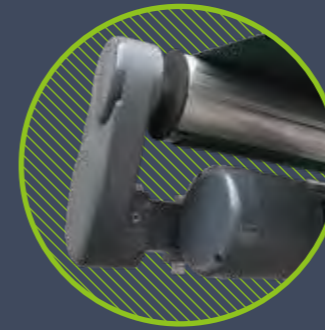

#### Description:

Heavy duty structure, quality dual-spring tension arm structure, robust and durable folding arms, built-in rain channel aluminum front bar, protect the valance from dropping rain. It can cover large areas of up to 6.0 m in width and 4.0m in projection with only two arms. Thanks to several awning structures join available, meet large sunshade area request. Available with manual and motorized operations.

Roller	Φ70mm,Φ80mm Aluminum or Steel
Front bar	Aluminum 70.18x62.59mm
Square bar	Steel 40x40mm
Arm	55x27mm/60x30mm
Extra strong arm	69x33mm/78x38mm
Gear Box	1:11
Adjusted-angle	5° to 75°
Frame	Outdoor Powder Coated
Connector	Aluminum Die Cast
Max size per unit	Width 6.0m,Projection 4.0m
Arms Available	1.5m,2.0m,2.5m,3.0m,3.5m,4.0m

#### 产品描述:

优质的弹簧材料，加上独特的双弹簧结构，使得手臂力量大稳定；铝合金外展杆上精心设计的导雨槽，保护荷叶边免受雨水冲蚀。2支手臂即可达到单套最大篷宽6.0m，展幅4.0m,可多套组合拼接，实现大面积遮阳需求。这款遮阳篷可选取电动操作和遥控装置。

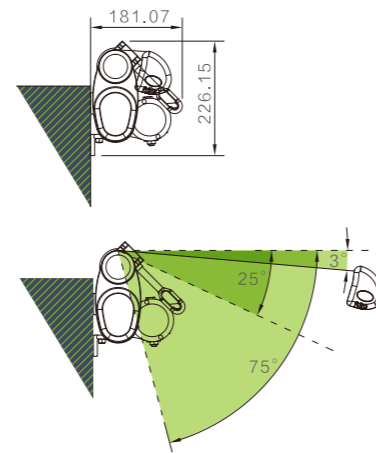

建议 ( Proposal ) : 15°~25°



66004 Cable Arm



66004S Chain Arm



67008 Aluminum support cap



66018 Central support

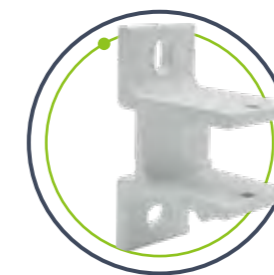

66017 Aluminum wall bracket 40mm

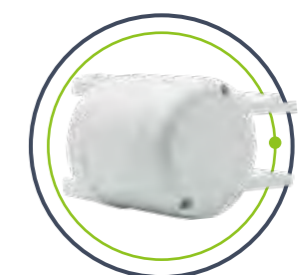

67006 New arm & bar connector

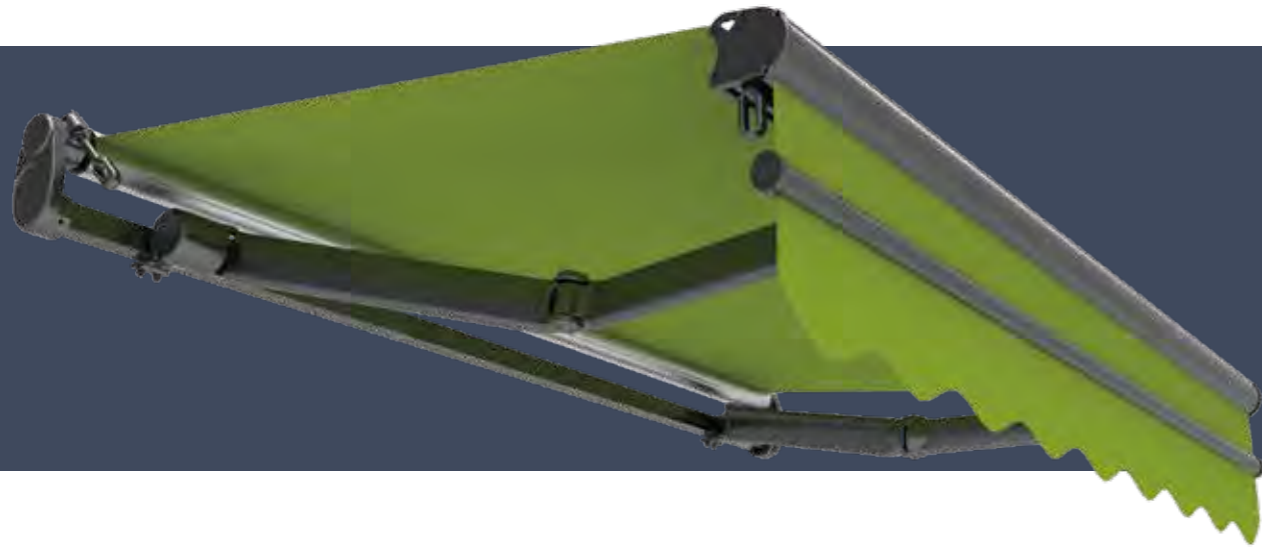

#### Description:

Heavy duty structure with dropped valance which can protect people from sunlight better. It can cover large areas of up to 6.0 m in width and 4.0 in projection with only two arms. Thanks to several awning structures join available, meet large sunshade area request. Available with manual and motorized operations.

#### 产品描述:

优质的弹簧材料，加上独特的双弹簧结构，使得手臂力量大稳定；铝合金外展杆上精心设计的导雨槽，保护荷叶边免受雨水冲蚀。2支手臂即可达到单套最大篷宽6.0m，展幅4.0m，可多套组合拼接，实现大面积遮阳需求。这款遮阳篷可选取电动操作和遥控装置。

Roller	Φ70mm,Φ80mm Aluminum or Steel
Front bar	Aluminum 90.57x77.2mm
Square bar	Steel 40x40mm
Arm	76.2x33.8x1.82mm/66.5x32x1.37mm
Gear Box	1:11
Adjusted-angle	5° to 75°
Frame	Outdoor Powder Coated
Connector	Aluminum Die Cast
Max size per unit	Width 6.0m, Projection 4.0m
Arms Available	1.5m, 2.0m, 2.5m, 3.0m, 3.5m, 4.0m

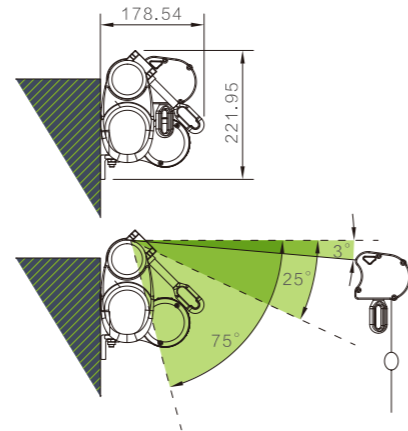

建议 ( Proposal ) : 15°~25°



68004 Cable Arm



68004S Chain Arm



67008 Aluminum support cap



66018 Central support

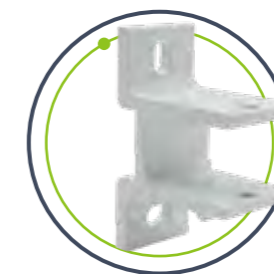

66017 Aluminum wall bracket 40mm



67006 New arm & bar connector

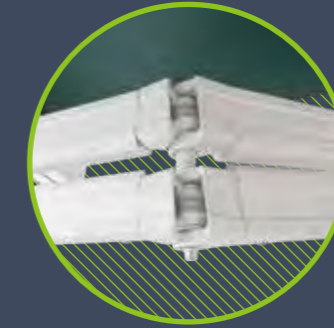
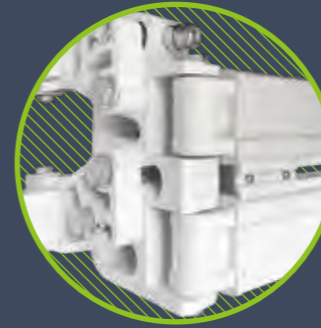
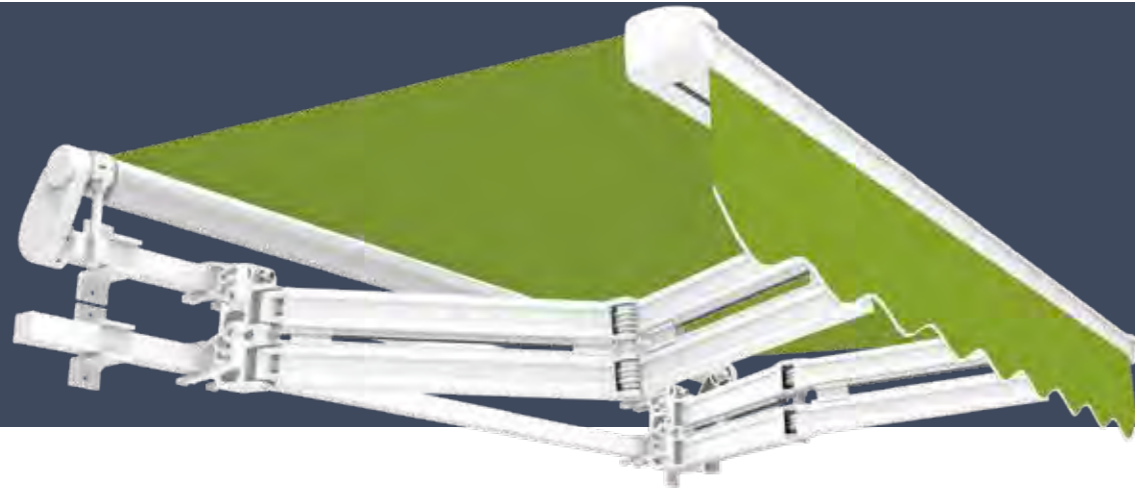

#### Description:

This big mac awning is designed with double arm set and extra bigger front bar which strengthen the whole structure. The maximum arm size is 5.0m. The maximum space it can cover is 30 square meter. Same to all other Greenawn awnings, pure aluminum material 6063 and high quality powder coating MetalBond keep the awning from corrosion and color changed in the open air.

#### 产品描述:

这款遮阳篷采用双手臂设计，加强了整个篷的架构，整个手臂在伸出可达5米，满足更大伸出空间的使用，算得上曲臂篷中的巨无霸。  
全优质不锈钢紧固件连接，高强度铝合金骨架，骨架使用户外喷粉表面处理，超强的耐腐蚀性能。

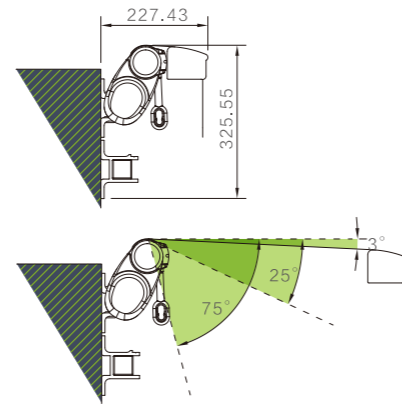

建议 ( Proposal ) : 15°~25°

Roller	Φ70mm,Φ80mm Aluminum or Steel
Front bar	Aluminum 86.35x69.1mm
Square bar	Steel 40x40mm
Arm	76.2x33.8x1.82mm/66.5x32x1.37mm
Gear Box	1:11
Adjusted-angle	5° to 75°
Frame	Outdoor Powder Coated
Connector	Aluminum Die Cast
Max size per unit	Width 6.0m,Projection 5.0m
Arms Available	1.5m,2.0m,2.5m,3.0m,3.5m,4.0m,4.5m,5.0M



69004 Cable Arm



69004SChain Arm



66018 Central support

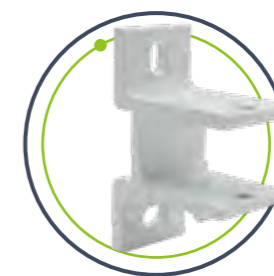

66017 Aluminum wall bracket 40mm



67008 Aluminum support cap

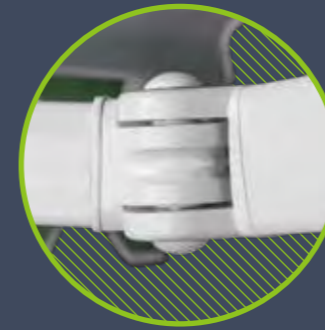
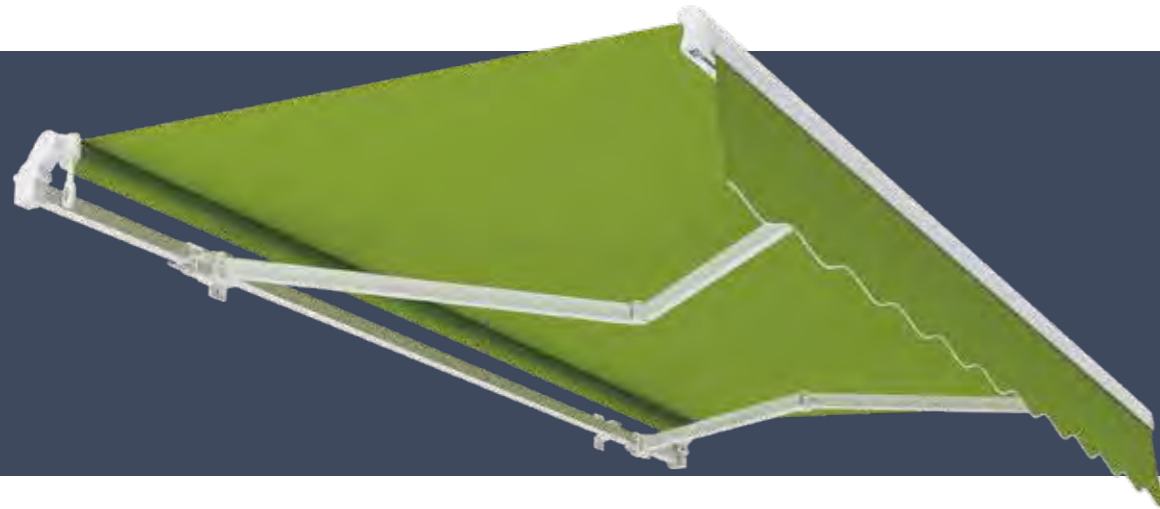

#### Description:

Heavy duty structure, quality dual-spring tension arm structure, robust and durable folding arms, elegant built-in rain channel aluminum front bar, protect the valance from dropping rain. It can cover large areas of up to 6.0 m in width and 4.0 in projection with only two arms. Thanks to several awning structures join available, meet large sunshade area request. Support manual and motorized operations.

Roller	Φ70mm,Φ80mm Aluminum or Steel
Front bar	Aluminum 90x65mm
Square bar	Steel 40x40mm
Arm	54x25mm/60x29mm
Extra strong arm	69x33mm/78x38mm
Gear Box	1:11
Adjusted-angle	5° to 75°
Frame	Outdoor Powder Coated
Connector	Aluminum Die Cast
Max size per unit	Width 6.0m,Projection 4.0m
Arms Available	1.5m,2.0m,2.5m,3.0m,3.5m,4.0m

#### 产品描述:

优质的弹簧材料，加上独特的双弹簧结构，使得手臂力量大稳定；铝合金外展杆上精心设计的导雨槽，保护荷叶边免受雨水冲蚀。2支手臂即可达到单套最大篷宽6.0m，展幅4.0m,可多套组合拼接，实现大面积遮阳需求。这款遮阳篷可选取电动操作和遥控装置。

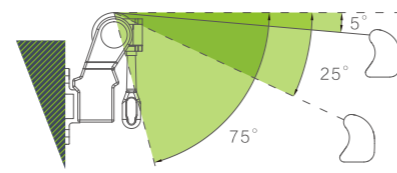
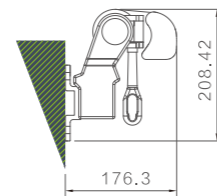

建议 (Proposal) : 15° ~25°



66004 Cable Arm



66004S Chain Arm



66005 Arm connector  
&  
66006 retainer



66018 Central support

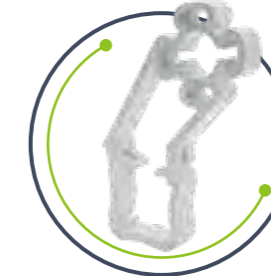

66008 Support bracket

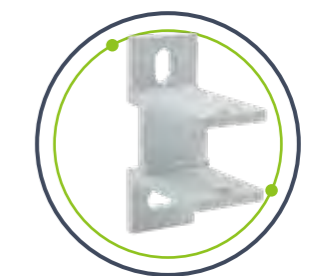

66017 Aluminum wall bracket 40mm

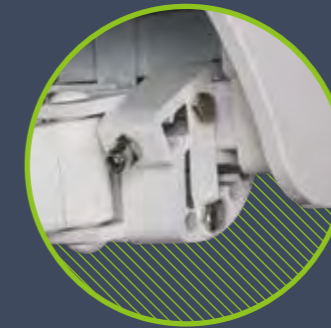
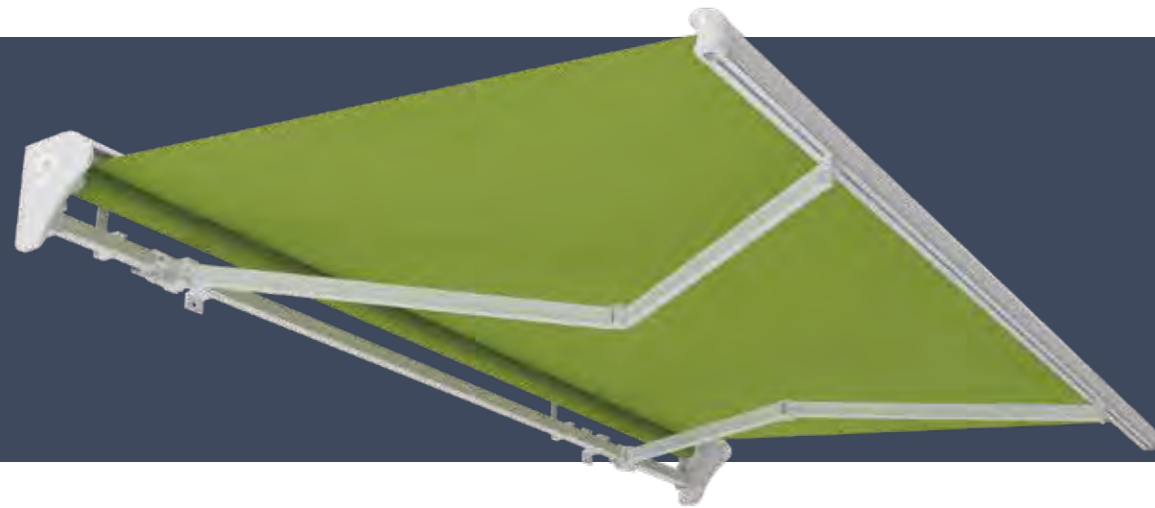

#### Description:

Semi-Cassette Awning, which can protect the fabric from dust and rain when it is closed. It is available with manual operation as well as motorized operation. The working inclination is 5°~ 75°. The maximum width is 6.0 m and projection 4.0 m.

#### 产品描述:

半盒曲臂式遮阳篷，其特征在于遮阳面料能被纳入罩壳内，可通过手动曲柄操纵、电机操纵传动系统使用机械装置和曲臂装置系统，在弹簧的作用下，产生伸缩张力，整个曲臂组由臂止动件实现5°~75°度任意精确平行调整。最大适用长度6.0m，最大适用伸出长度为4.0m。

Roller	Φ70mm,Φ80mm Aluminum or Steel
Front bar	Aluminum 90x65mm
Square bar	Steel 40x40mm
Flashing(UPPER)	128.8mm
Flashing(NETHER)	109mm
Arm	54x25mm/60x29mm
Gear Box	1:11
Adjusted-angle	5° to 75°
Frame	Outdoor Powder Coated
Connector	Aluminum Die Cast
Max size per unit	Width 6.0m,Projection 4.0m
Arms Available	1.5m,2.0m,2.5m,3.0m,3.5m,4.0m

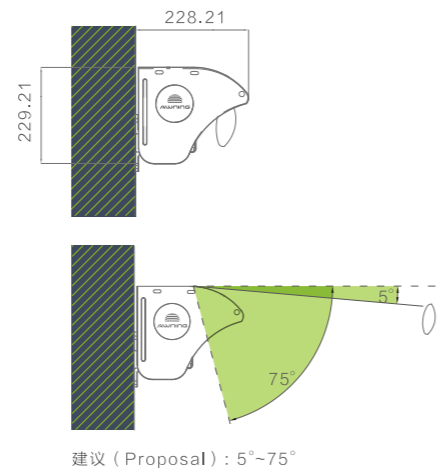

66004 Cable Arm



66004S Chain Arm



66005 Arm connector  
&  
66006 retainer

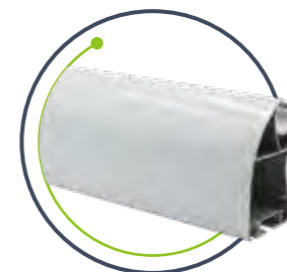

66003 front bar



66008 Support bracket

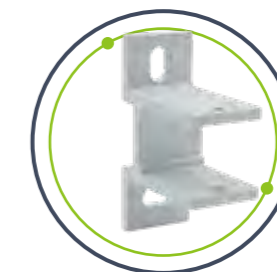

66017 Aluminum wall bracket 40mm

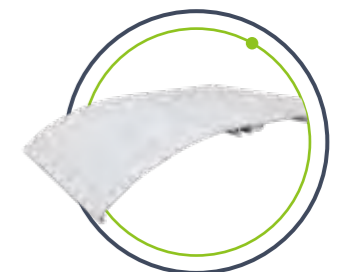

58204&58205 Flashing

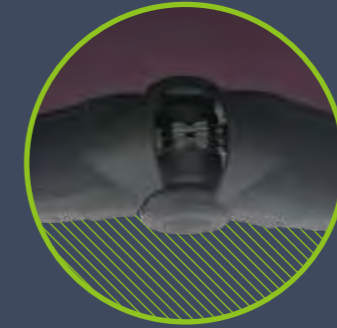
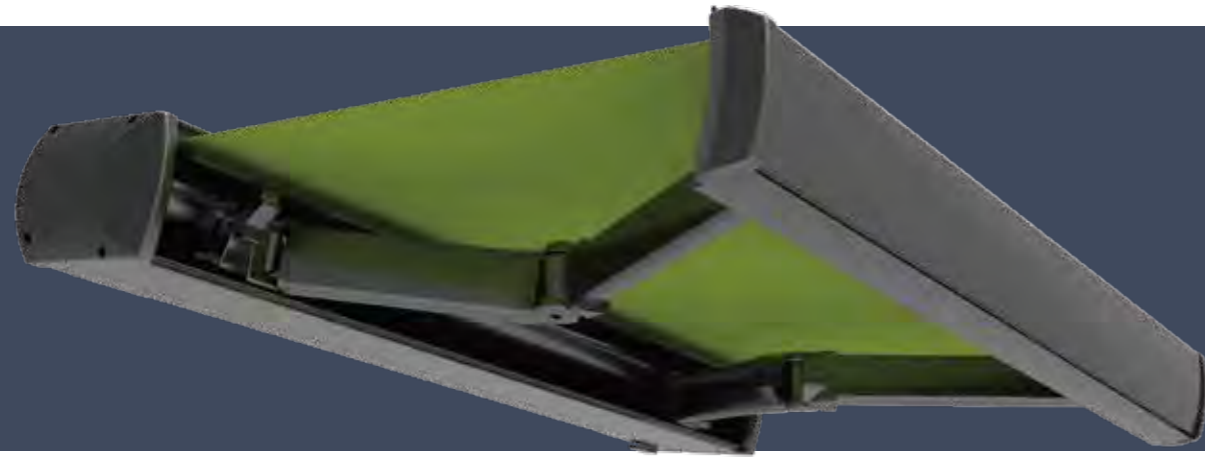

**Description:**

Folding chain arms replace the traditional cable arms. Special mechanism guarantees that full cassette awning will close perfectly. Italian style full cassette design, stylish outer look, providing fabric and awning structure a better protection. It can cover areas of up to in projection it can Cover areas of up to 7.0 min width 3.5m in projection and reach 5-70 angle adjustment

Roller	Φ70mm/80mm Steel
Front bar	Aluminum 148×65mm
Arm	75×36mm/66×31mm
Gear Box	1:11
Adjusted-angle	15° to 25°
Frame	Outdoor Powder Coated
Connector	Aluminum Die Cast
Max size per unit	Width 7.0m, Projection: 3.5m
Arms Available	1.5m, 2.0m, 2.5m, 3.0m, 3.5m

**产品描述:**

格绿朗全盒式曲臂遮阳篷  
双钢链手臂取代传统的钢丝手臂，特殊的机械机构保证了任意角度下罩壳吻合的完整性。意大利全罩壳设计，外观更时尚；使篷布与机构得到更严密的保护；单套最大长度7米，臂伸3.5米，可实现5°~75°自由角度调节。

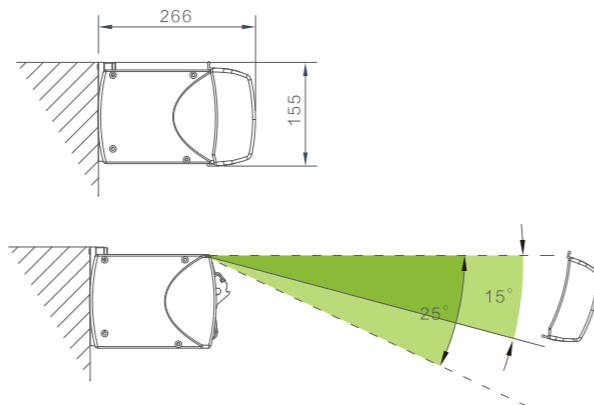

建议 (Proposal) : 15°~25°



68004 Cable Arm



68004S Chain Arm



83017 Wall bracket

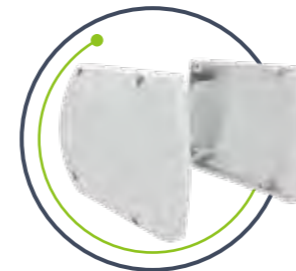

83007 Reel support part cap



83005 Reel support

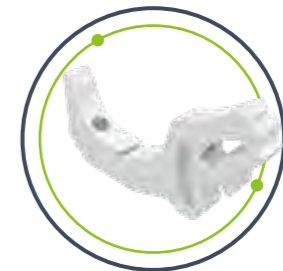

83201 Central support



83003 Aluminium front bar

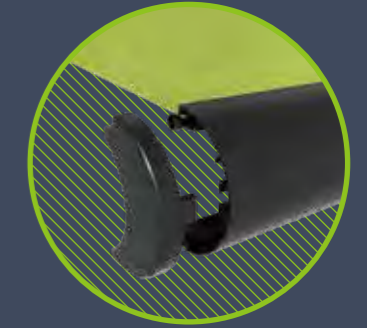
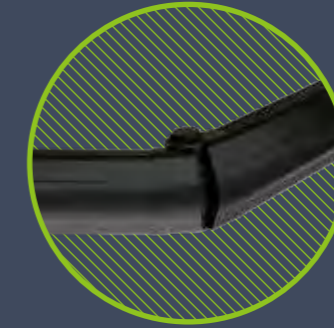
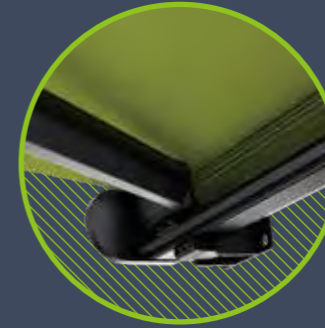
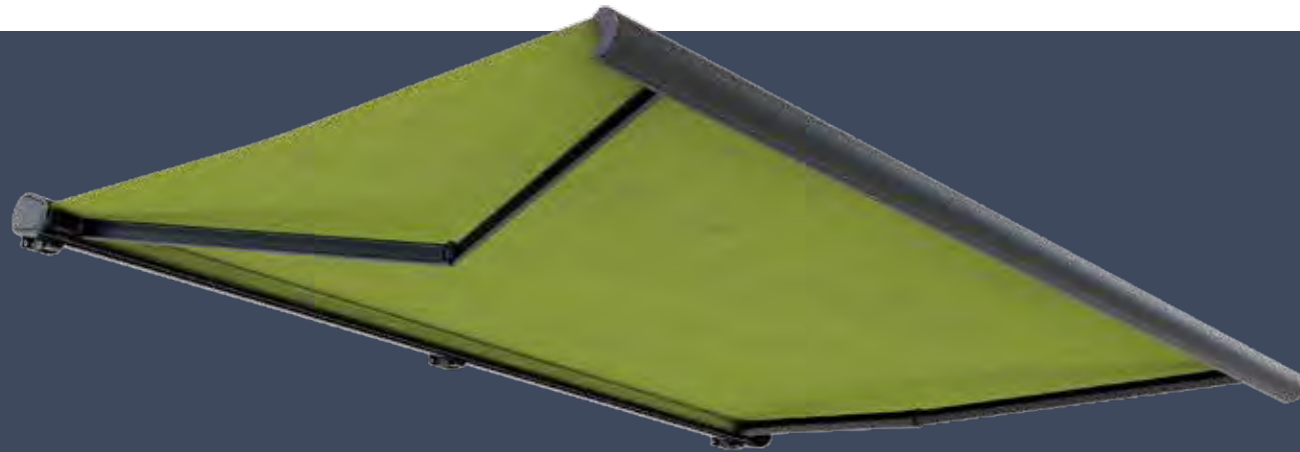

### Description:

GR850 full cassette awning can use for residential, Merchants, clubs, villas and other living scenes. Elegant curved appearance, one piece Design; Even at night, simple bright lights is still dazzling; The width size can be made 2-7 meters & projection 1.5-3.0 meters

### 产品描述:

全盒式遮阳篷适用于住宅、商户、会所、别墅等生活场景。优雅的弧形外观，一体的设计；即使在夜晚，简约明亮的灯光系统依然夺目；全盒式遮阳篷单套尺寸可做到宽度2-7米，伸出1.5-3.0米

Roller	Φ70mm Steel
Front bar	Aluminum 130.9×91.9mm
Cassette	Aluminum 170.1×149.3mm
Arm	71.3×39.8×1.9mm/63.8×32.1×1.8mm
Gear Box	1:11
Adjusted-angle	15° to 25°
Frame	Outdoor Powder Coated
Connector	Aluminum Die Cast
Max size per unit	Width 7.0m, Projection: 3.0m
Arms Available	1.5m, 2.0m, 2.5m, 3.0m

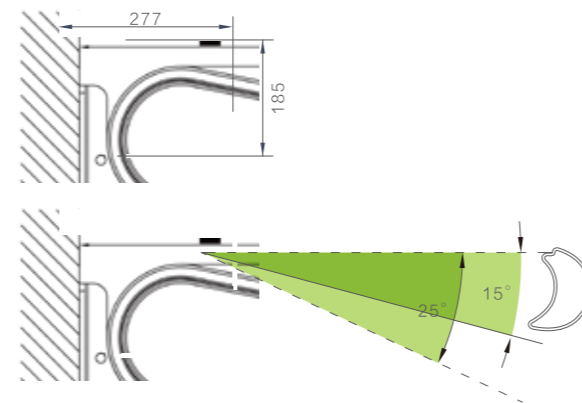

建议 (Proposal) : 15°~25°

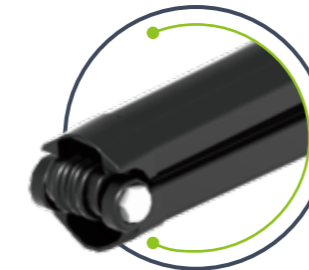

85007 Folding arm

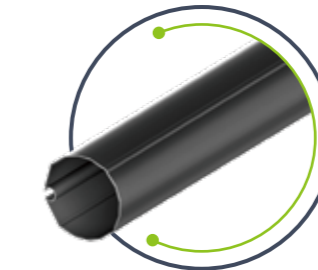

66015 Tube

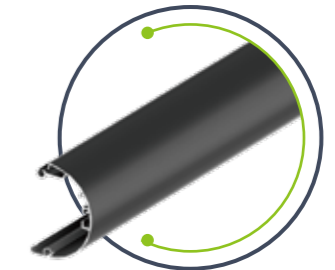

85003 QHC front bar

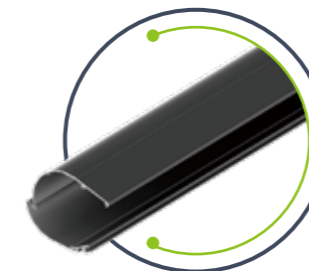

85004 QHC back cover



85008 QHC back cover cap



85014 QHC wall bracket

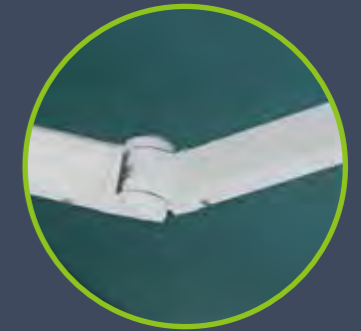
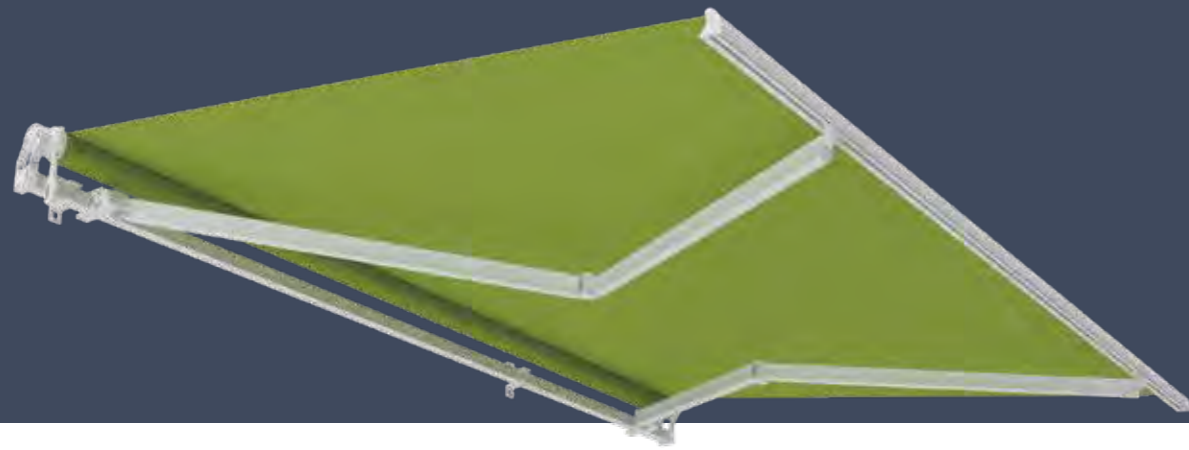

### Description:

Light style awning with simple design which is convenient for carry, dispatch and install. High quality aluminum material and good quality powder coating make the awning a higher level compare to other economical awnings. Light structure, good quality, durable awning.

### 产品描述:

轻型简易的设计，便于搬运、运输和安装，高质量的铝材加上高要求的户外喷涂标准，让此曲臂篷明显区别于其它简易篷，层次更高一层。轻简的骨架，高质量的铝材，成就一套经济耐用的遮阳篷。

Roller	Φ60mm, Φ70mm Aluminum
Front bar	56x48mm, Aluminum
Square bar	35x35mm, steel
Arm	52x26mm/57x32mm
Gear Box	1:7
Max size per unit	Width 4.0m, Projection 3.0m
Arms Available	1.5m, 2m, 2.5m, 3m

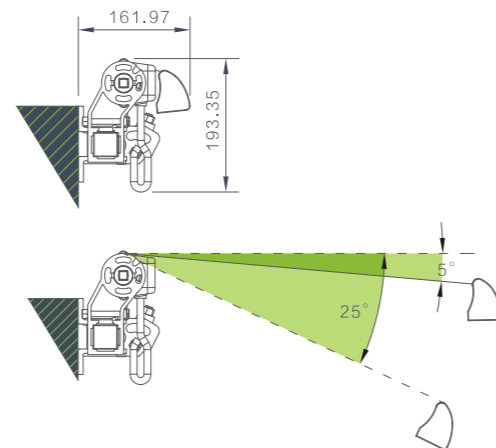

建议 ( Proposal ) : 5°-25°

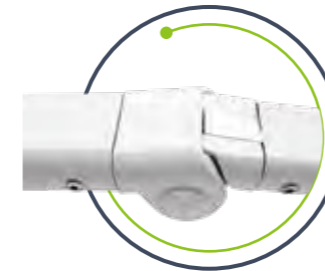

22014 Cable Arm



22014 Cable Arm

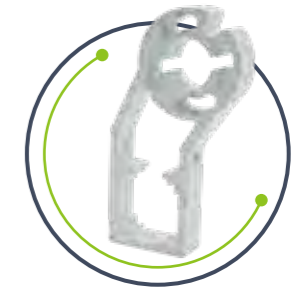

22008 Support part

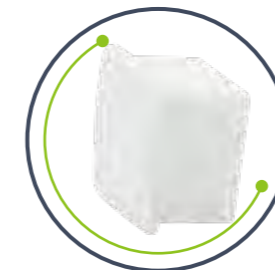

22013 Square bar cap

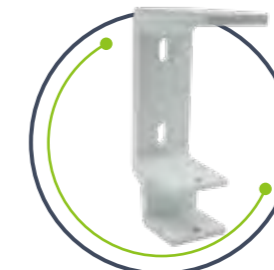

22017A Steel ceiling bracket 35mm

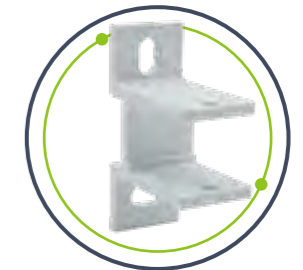

22017 Aluminum wall bracket 35mm

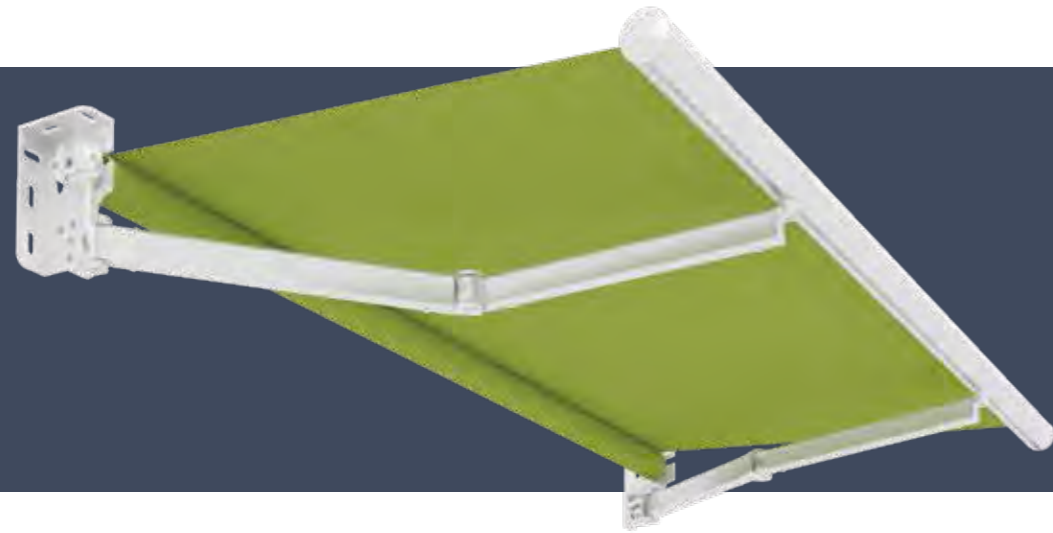

GR-100

### Description:

This simple awning is designed for economical use. The high strength aluminum structure make it a maximum projection 3.0m.

### 产品描述:

此款产品的结构骨架采用高强铝合金、优质钢材、ABS树脂等制成。特点简单，紧凑牢固，在弹簧的作用下，产生伸缩张力，整个曲臂组可实现5°至60°任意精确平行调整；最大适用伸出长度为3.0m。

Roller	Φ65mm Aluminum
Front bar	65mm, Aluminum
Arm	52X26mm / 57X31mm
Gear Box	1:11
Frame	Outdoor Powder Coated
Max size per unit	Width 4.0m, Projection 3m
Arms Available	1.5m, 2.0m, 2.5m, 3m

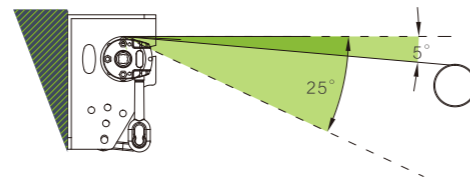
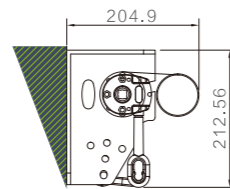

建议 (Proposal) : 15°~25°

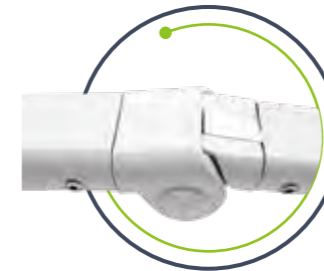

22014 Cable Arm



10005 Gear box

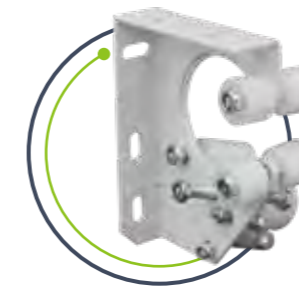

10009 Central support



10006 Side bracket

**INTELLIGENT  
WINDOW AWNING**  
智能窗式篷系列

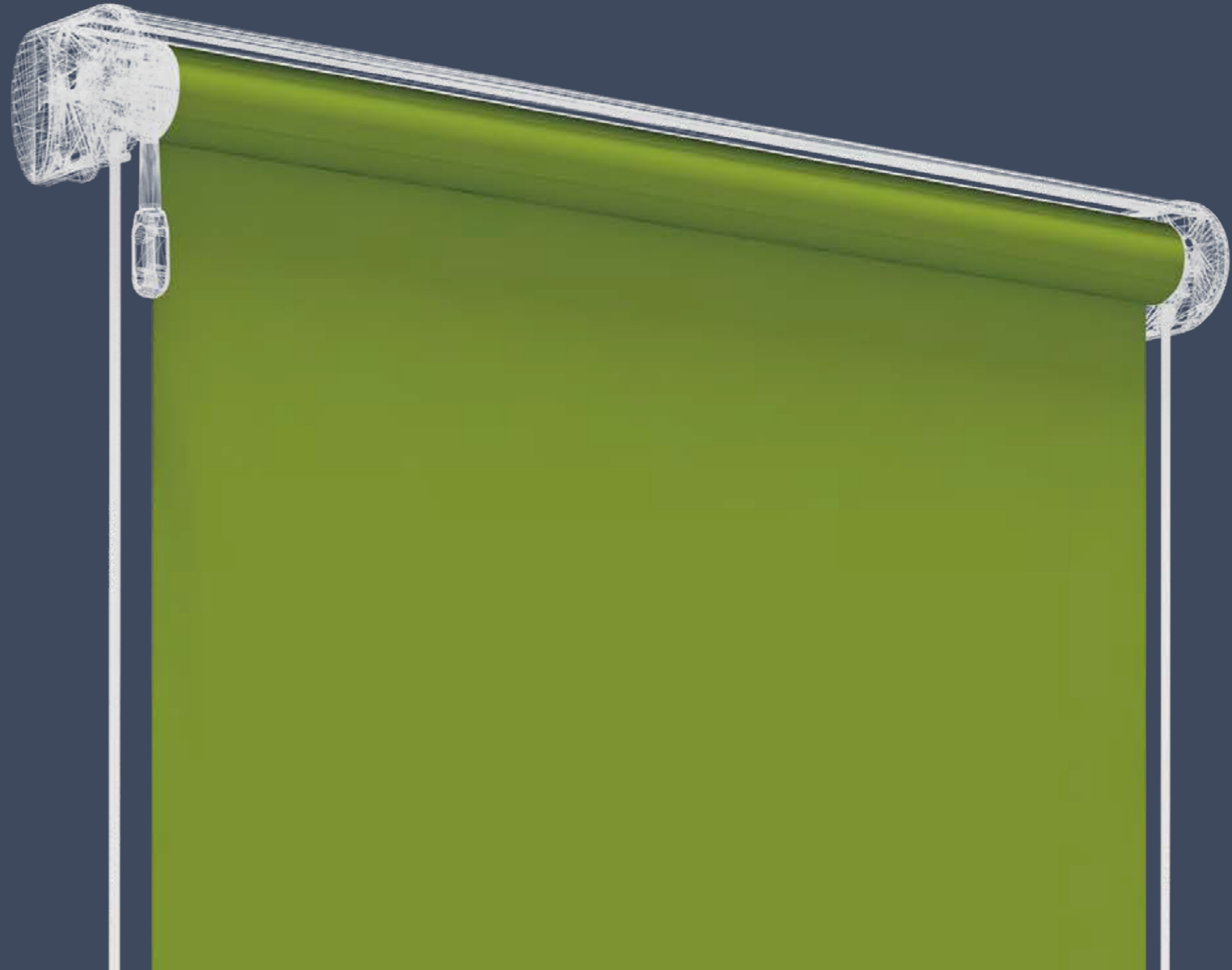

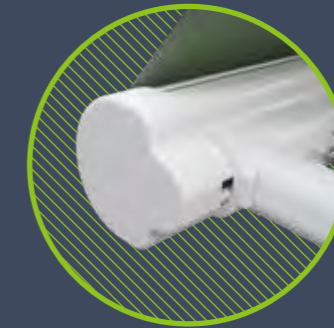

### Production Description:

High quality steel cable and spring make the arm strong and stable. It is more flexible and noiseless during rolling in & out. It can be dropped to 135°, obtained the ideal shade effect. The use of special techniques to ensure its incomparable durability and the best tarpaulin tight force, effectively adjust the light intensity at the same time, to keep the indoor air flow.

The max width: 4.0 meter

The max projection: 1.4 meter.

The perfect shading system provided consumers ventilation and landscape with unique mesh fabric

Roller	Φ70mm Aluminum or Steel
Front bar	Aluminum 75.5x71mm
Arm	35x26mm
Flashing	123.2x32mm
Flashing Fixing plate	54x10mm
Max size per unit	Width 4,0m, Projection: 1.4m
Arms Available	1.0m,1.2m,1.4m

### 产品描述:

配置内置遥控电机、发射器;专用优质品牌钢丝和弹簧,使摆臂力量更强,更稳定;伸展和收回过程中灵活而且无噪声,垂臂轴135°角的旋转,让窗户得到理想的遮阳效果。专用技术的运用保证其无与伦比的耐久力和最佳的篷布紧绷力,有效调节光线强弱的同时,保持室内的空气流动。单套最大宽度4.0M,最大伸出1.4M,搭配特有网孔面料,既透风又透景,为用户提供完美遮阳方案。

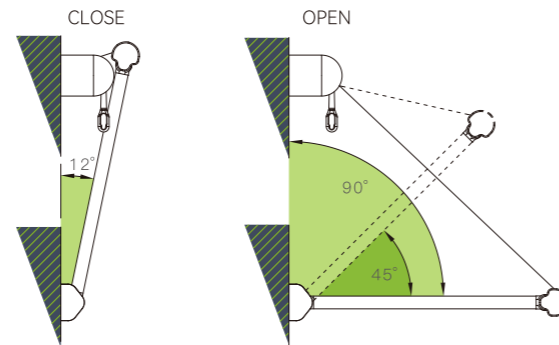

建议 (Proposal) : 45 °~90°

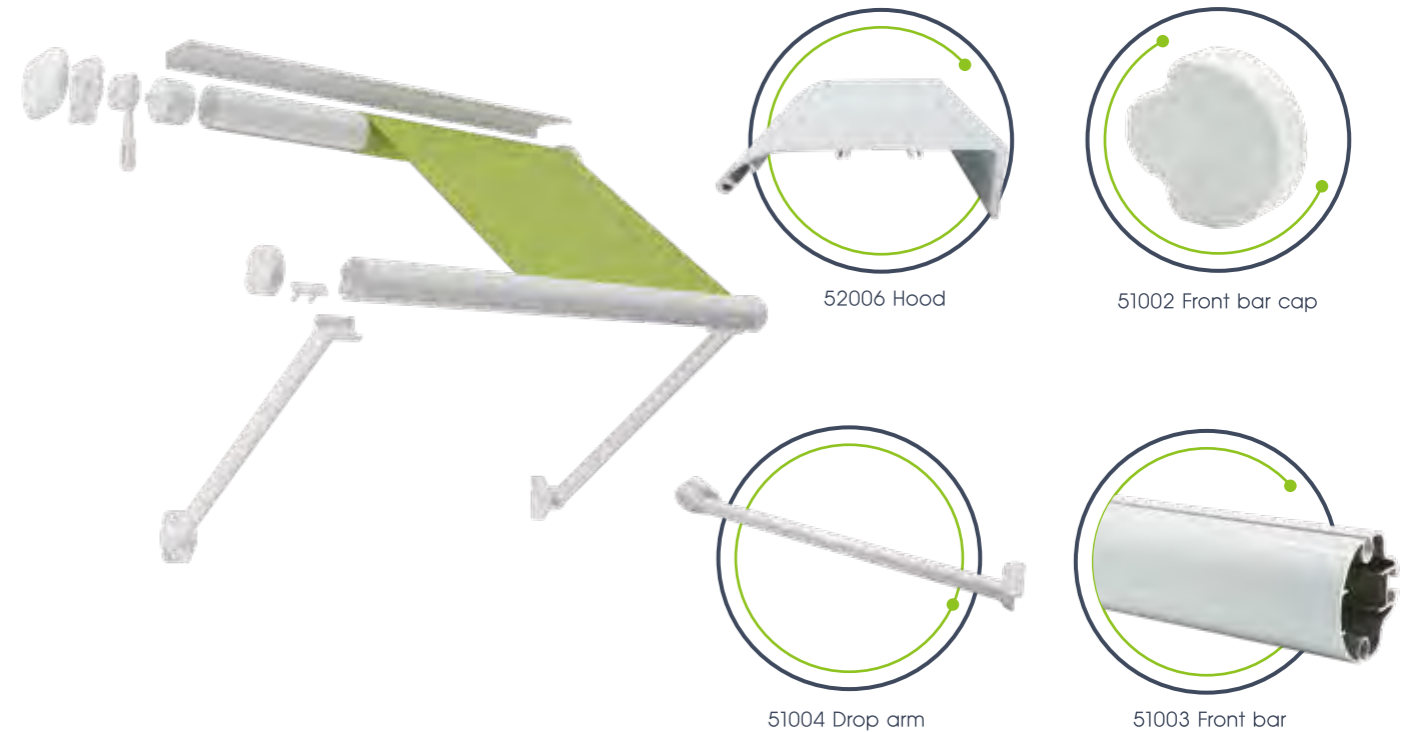

## Production Description:

### Intelligent Window Awning

Good fitting window frame, freely slide up and down and easily operation with good shading. Design for higher window with diameter 6mm steel cable. Concise, exquisite and durable design. The perfect shading system provide consumers a ventilation and landscape with unique mesh fabric.

垂直贴合窗框，上下自由滑动具有良好的遮光效果，性能稳定操作简便；6mm的不锈钢线，专为较高的窗户搭配设计，设计简洁、轻便、精致耐用，安全、稳定。搭配特有网孔面料，即通风又透景，提供完美遮阳方案。

Roller	Φ70mm Aluminum or Steel
Front bar	Aluminum 48.4x40mm
Stainless wire	Φ6mm
Flashing	123.2x32mm
Flashing Fixing plate	54x10mm
Packing	Each pc/Cartron
Max size per unit	Width 5.0m, Projection: 3.0m

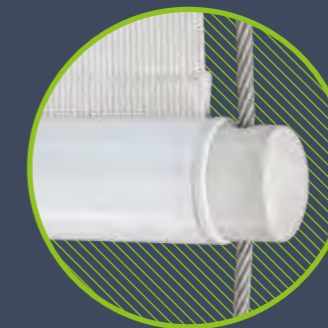
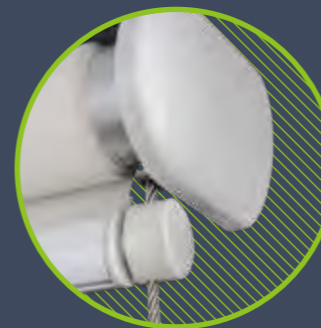
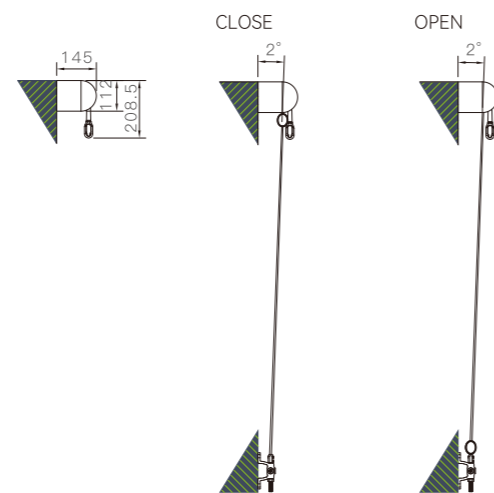

52006 Hood

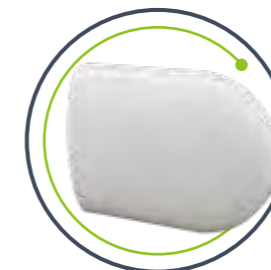

52001 Plastic end cap

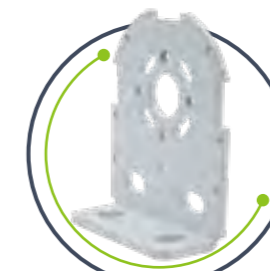

52017 Steel side bracket



**Production Description:**

Intelligent Window Awning

Smooth outline fit for wall and window, stable performance and easy operation. Designed for toughened glass exterior wall with dia 6mm steel rod. Concise ,exquisite and durable design. The perfect shading system provide consumers a ventilation and landscape with unique mesh fabric.

流畅的外轮廓适合墙面或窗框的个性化安装，性能稳定，操作简便；6mm的不锈钢条固定，专为钢化玻璃外墙使用，设计简洁、轻便、精致耐用，安全、稳定；搭配特有网孔面料，即通风又透景，提供完美遮阳方案。

Roller	Φ70mm Roller steel Aluminum.
Front bar	Aluminum 48x40mm
Rod	304 Stainless steel Rod 6mm
Flashing	123.2x32mm
Flashing Fixing plate	54x10mm
Packing	Each pc/Carton
Max size per unit	Width 5.0m, Projection: 3.0m

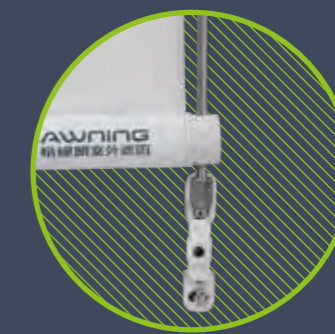
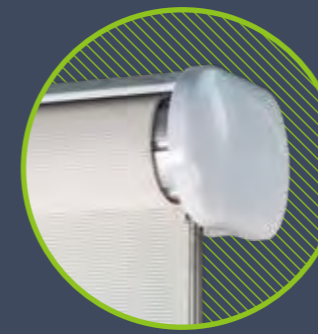
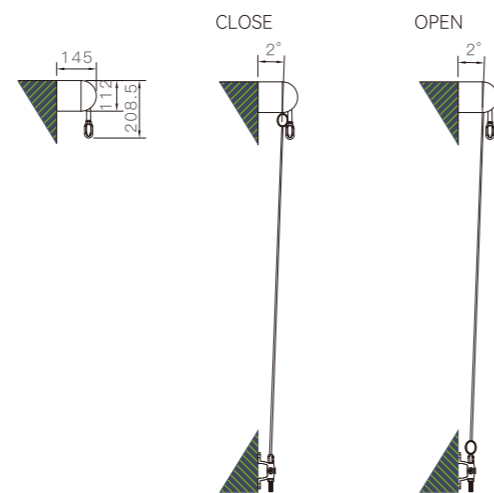

52006 Hood

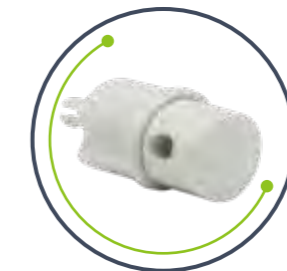

52033 Front bar end cap



52032 Front bar





**Production Description:**

Intelligent Window Awning

Smooth outline fit for wall and window installation, stable performance and easy operation. Concise, exquisite and durable design. The perfect shading system provided consumers a ventilation and landscape with unique mesh fabric.

流畅的外轮廓适合阳台或窗框上的个性化安装;性能稳定,操作简便;设计简洁、轻便、精致而耐用,安全、稳定;搭配网孔面料,既通风又透景,提供完美遮阳方案。

Roller	Φ70mm Aluminum or Steel
Front bar	Aluminum 48x40mm
Flashing	123.2x32mm
Flashing Fixing plate	54x10mm
Packing	Each pc/Carton
Max size per unit	Width 5.0m, Projection: 3.0m

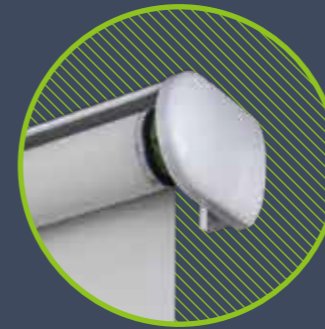
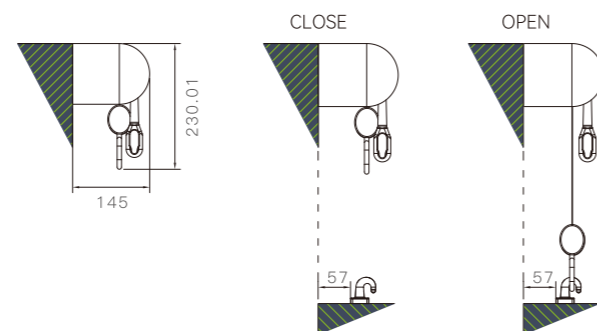

52006 Hood



52017 Steel side bracket



52009 Hook

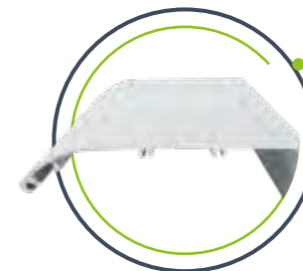

52032 Front bar

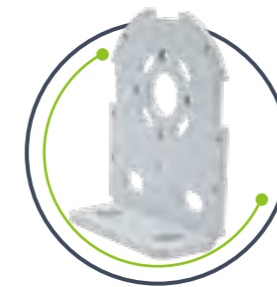

52009 Hook



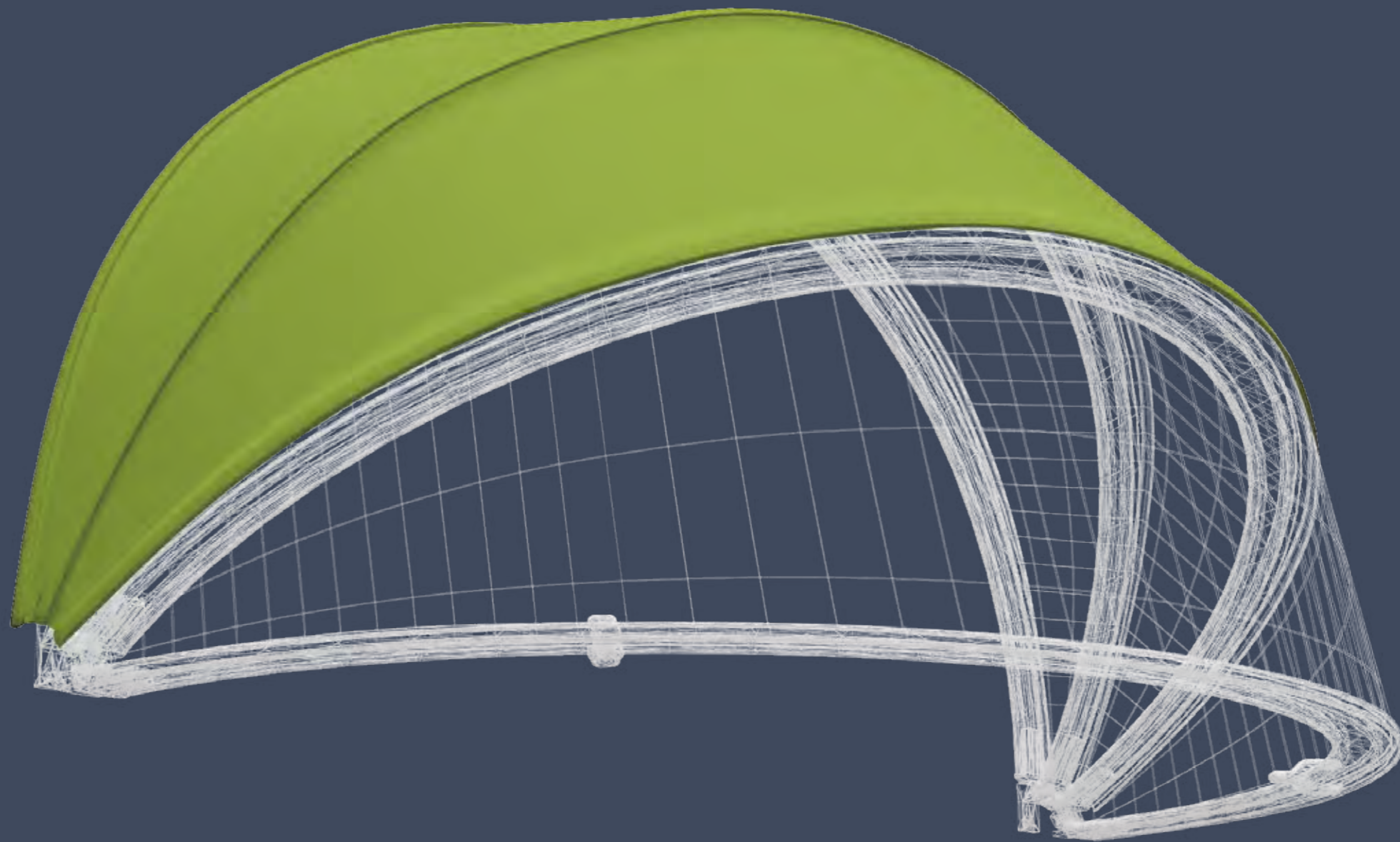

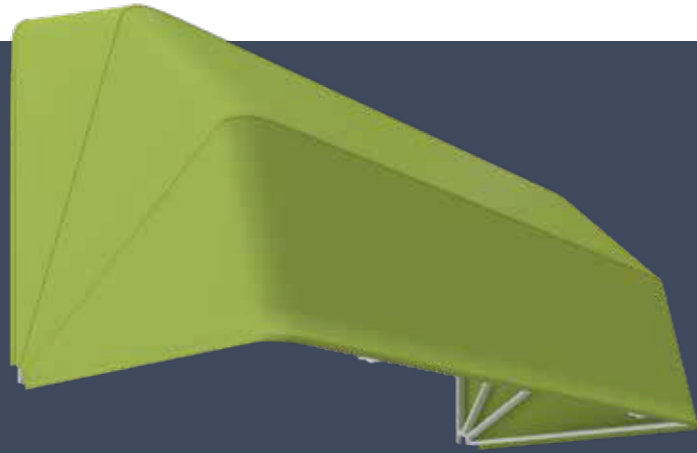

Description:

Frame	52.2x14.6mm Aluminum-anodized
Connector	Plastic or Aluminum
Packing	Each pc/Carton
Max size per unit	Width 6.0m, Projection: 1.2m

Description:

Frame	50.2x14.6mm Aluminum-anodized
Connector	Plastic or Aluminum
Packing	Each pc/Carton
Max size per unit	Width 3.0m, Projection: 1.5m

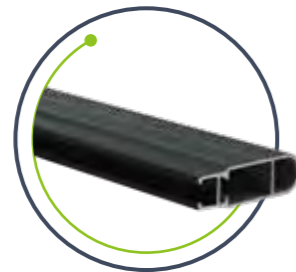
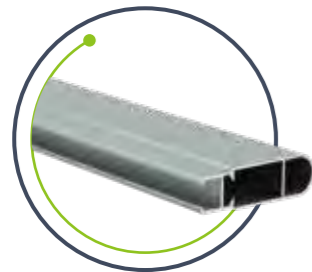
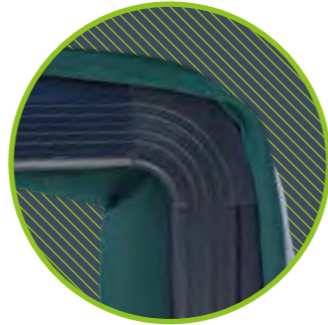
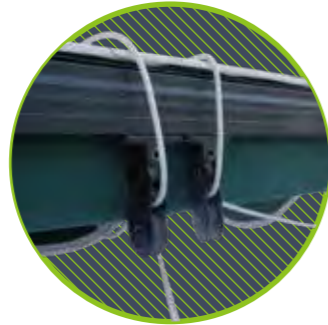
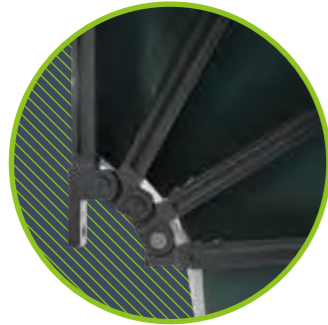

31006 Aluminum profile A

31006 Aluminum profile B

31003 Aluminum elbow connector

31003 Plastic elbow connector

31002 4 hinge connector

31001 Bracket

31004 Y Permanent yard

31005 Hung wheel



Description:

Frame	50.2x14.6mm Aluminum-anodized
Connector	Plastic
Packing	Each pc/Carton
Max size per unit	Width 6.0m, Projection: 1.2m

Description:

Frame	50.2x14.6mm Aluminum-anodized
Connector	Plastic or Aluminum
Packing	Each pc/Carton
Max size per unit	Width 3.0m, Projection: 1.5m

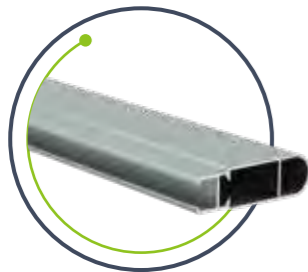
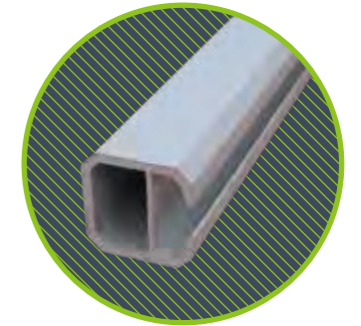
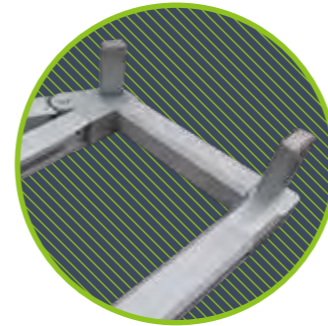
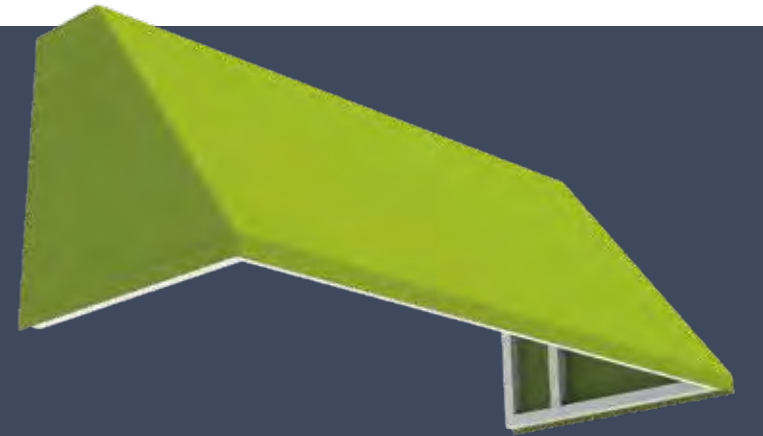

31006 Aluminum profile A

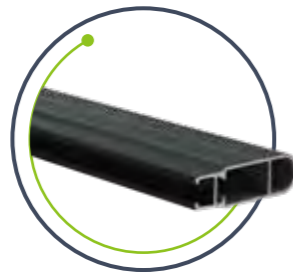

31006 Aluminum profile B



33001 Connector (two feet)



33002 Connector (one feet)

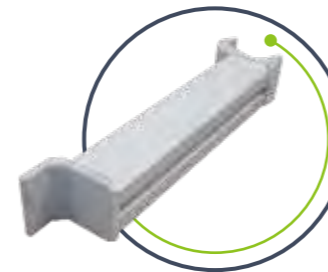

Aluminum tube

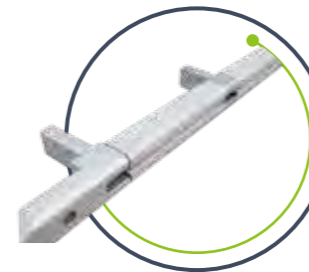

Connecting tube



Bracket

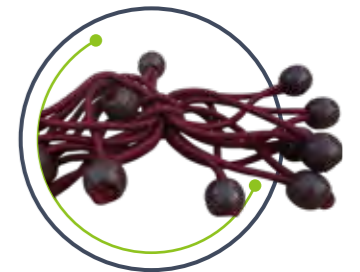

Roap

**CONSERVATORY  
AWNING**  
阳光房天幕系列

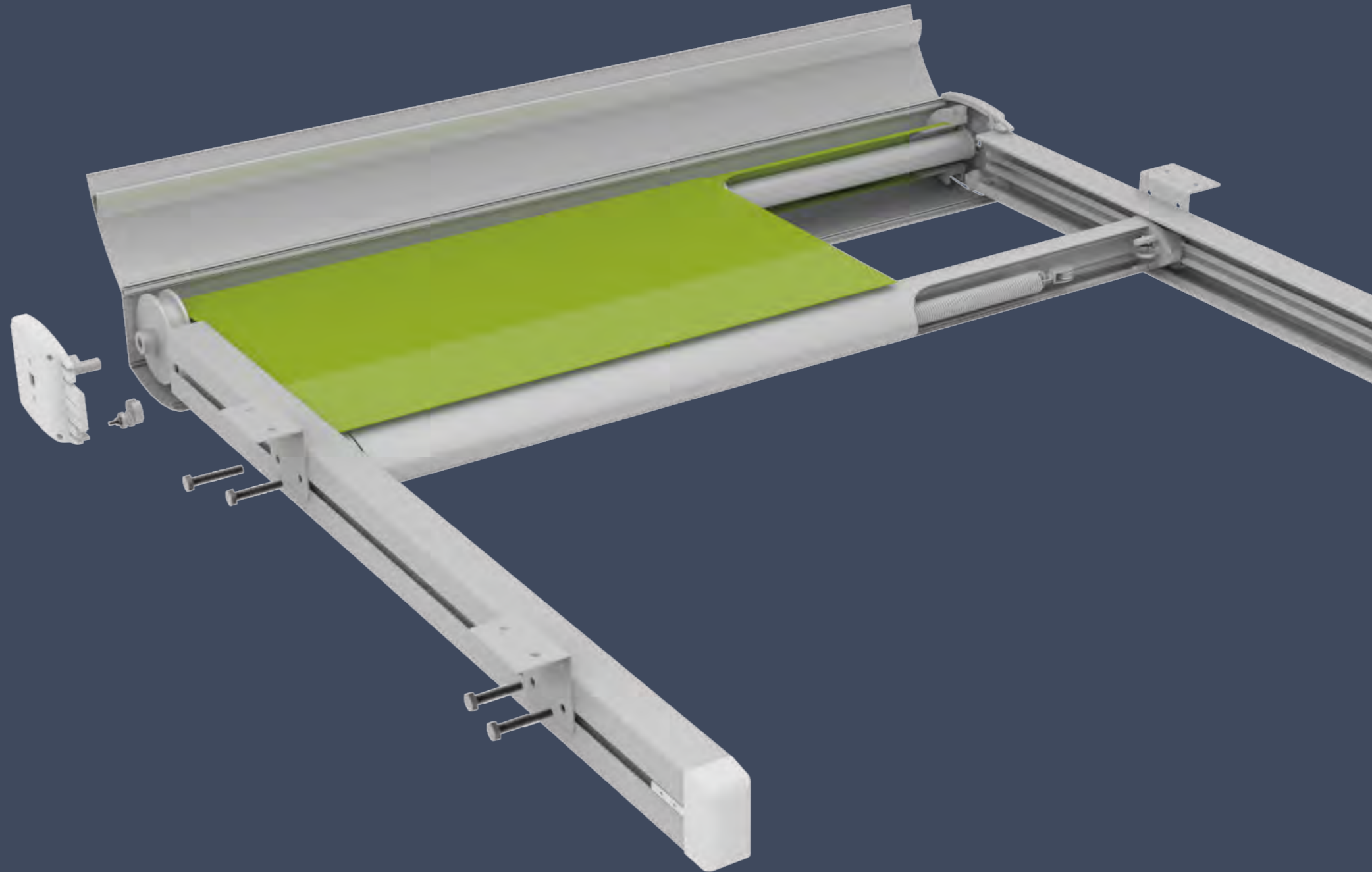

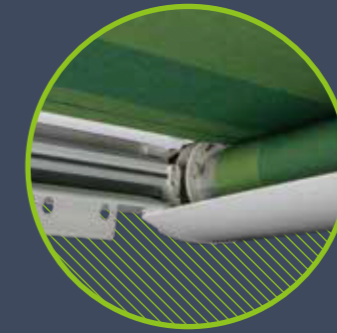
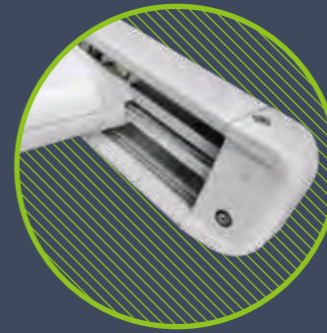
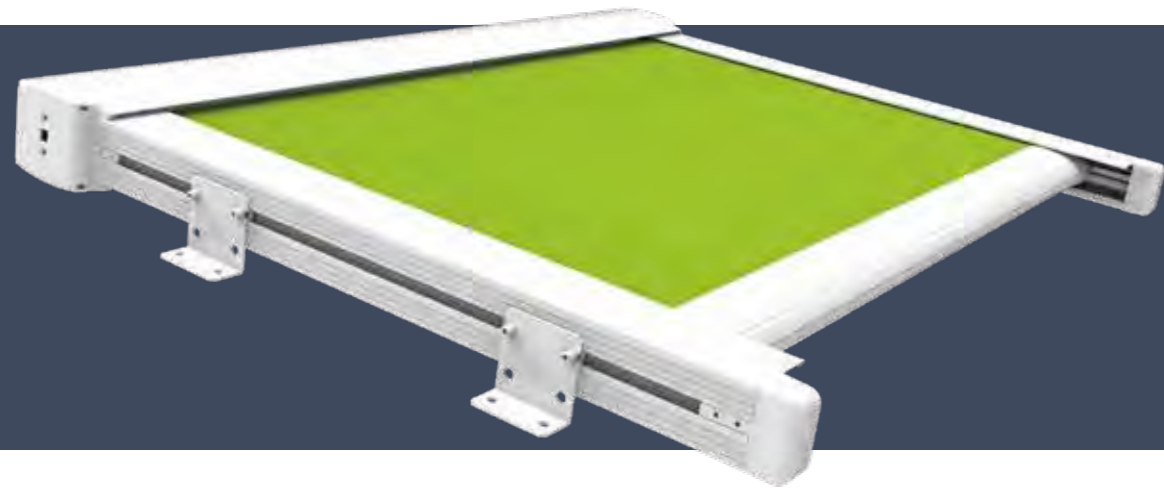

## Production Description:

Fully closed aluminum shell can protect the fabric very well. The unique structural design and tension device keep the tension fabric shade. The perfect rail system minimizes the noise. A support rod is necessary for big sizes to keep the fabric away from sagging under rain water.

Meanwhile, a certain inclination is required to facilitate drainage. A single set of the maximum width is 5.5 m, max projection to 6m.

### Heavy, Strong Aluminum Conservatory Awning

Roller	Φ80mm Aluminum
Cover(UPPER)	1655x325mm
Cover(NETHER)	1680x1260mm Aluminum 101x71mm
Front bar	100x88.2mm
Rail	Outdoor Powder Coated
Frame Connector	Aluminum Die Cast
Packing	Each pc/Carton
Max size per unit	Width 5.5m, Projection 6.0m

## 产品描述:

全封闭的铝合金罩壳保证了遮阳篷收回时保护好篷布，并且只占用145mm的高度空间，十分方便。

独特的结构设计及预张力装置，时刻保持遮阳布料张力，完善的导轨系统将噪声降至最低，以导轨末端伸出距离最近支座为0.6m。由于雨天积水时，遮阳面料受重下垂，因个别尺寸较大的遮阳篷要配置拖布辊，同时遮阳篷安装时要有一定倾斜度，以利排水。单套最大宽度5.5m，最大展幅6m，最大面积可达33m<sup>2</sup>/套，可大面积阻挡日晒，是阳光的最佳搭档，有效降低房内温度，使其变成宜人的凉爽空间。

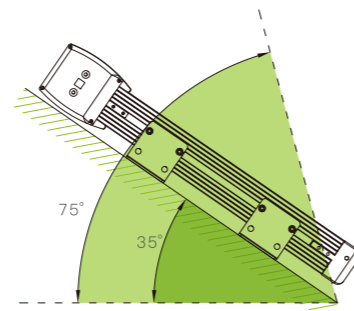

建议 (Proposal) : 5°~15°

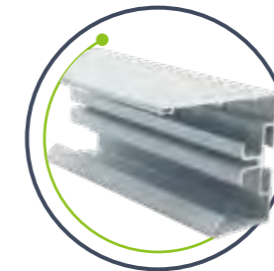

93015 Sliding rail

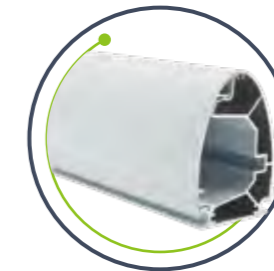

93009 Front bar



93012 Rail bracket



93002 Cover box



93003 Supporting board

The logo consists of a stylized green 'P' shape formed by multiple parallel lines, followed by the word 'PERGOLAS' in a bold, white, sans-serif font.

**PERGOLAS**  
室外电动天篷帘系列

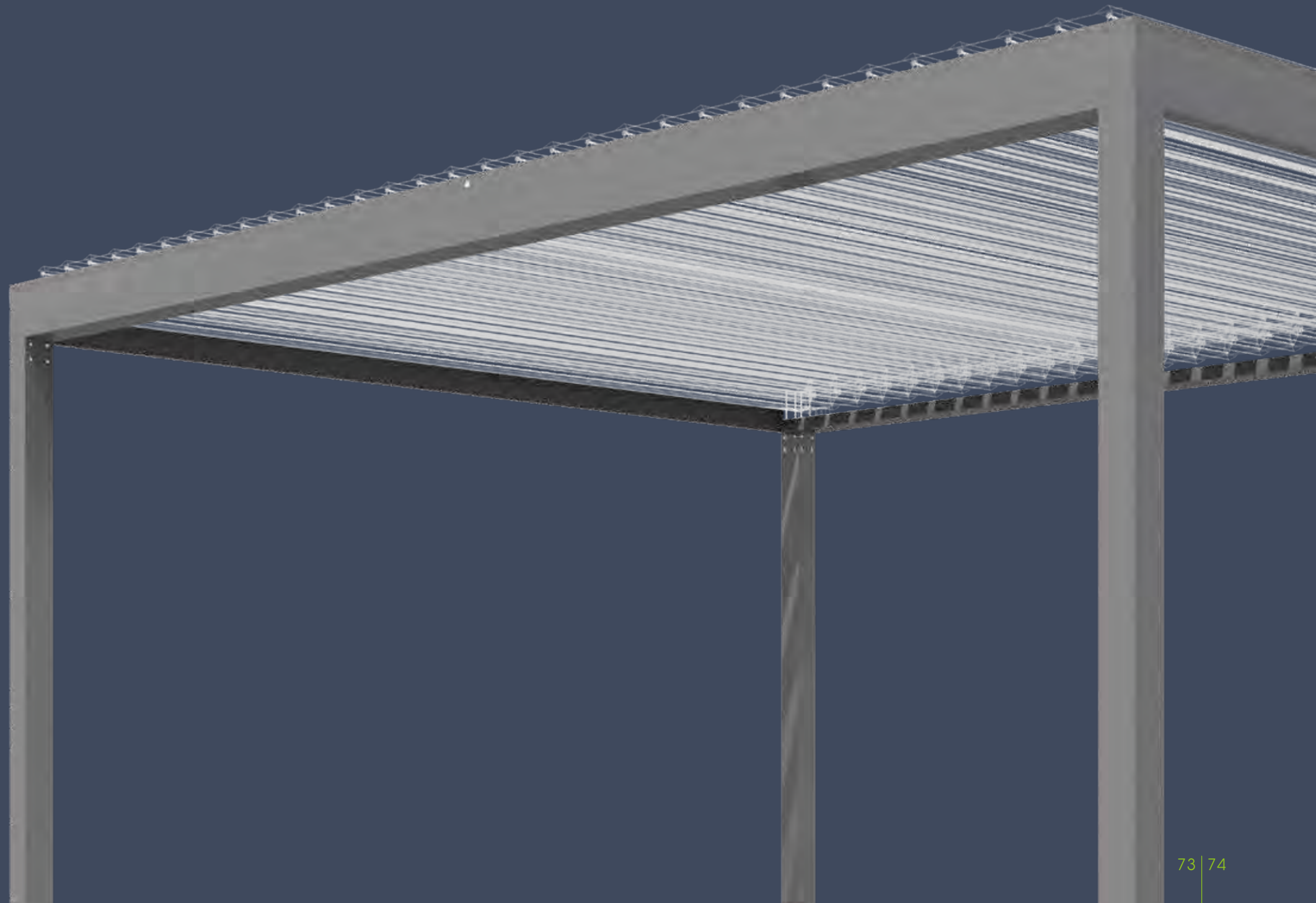

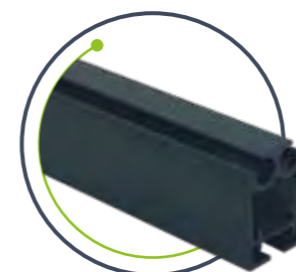
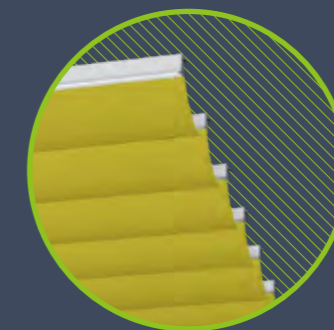
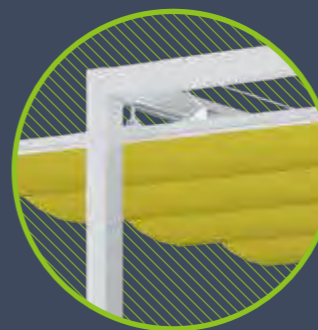
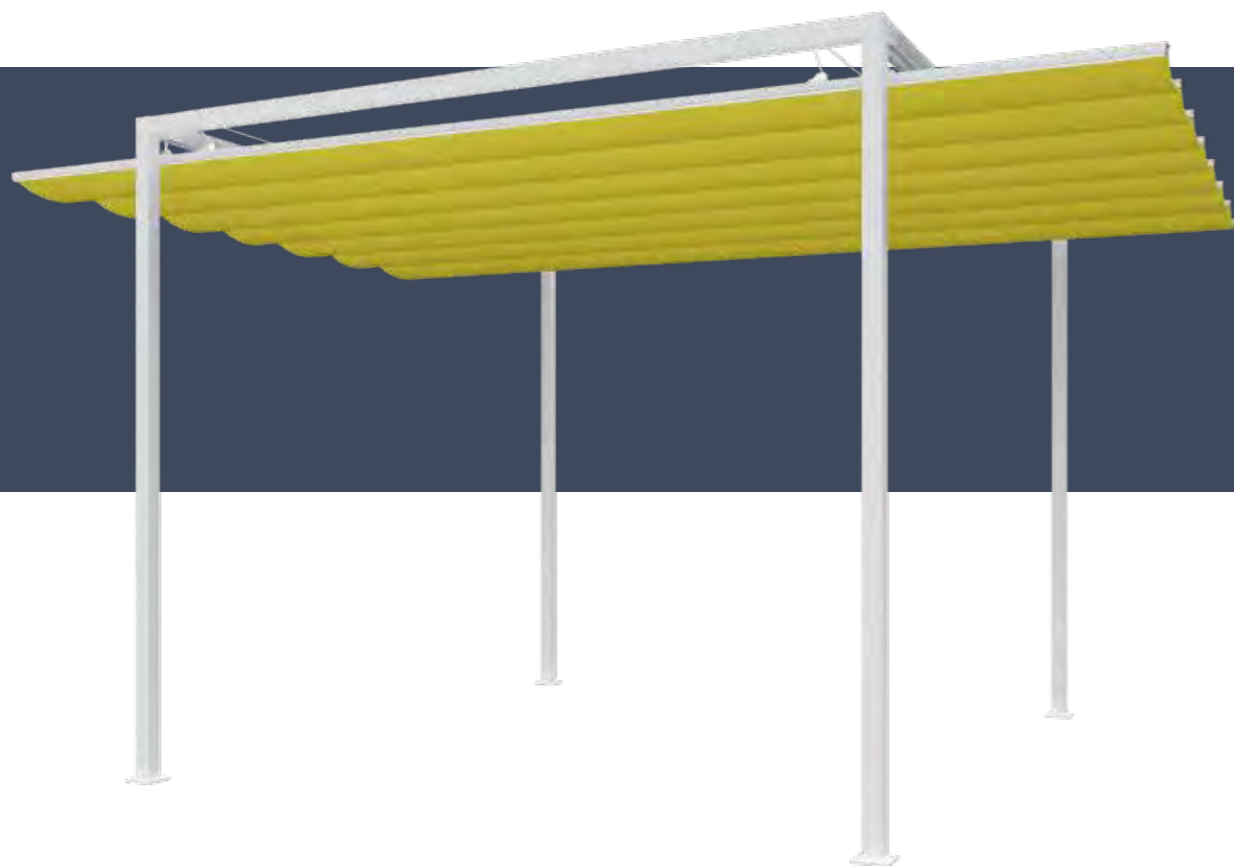

Dual hanging fabric bar



Rail

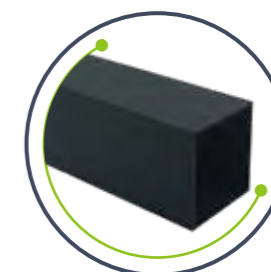

Post



Hanging wheel



Roller tube fastening part

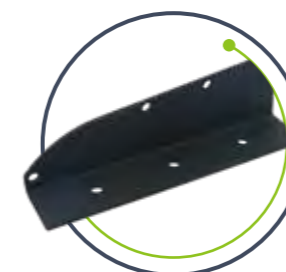

Waterproof hood cap



fastening part



Universal fastening bracket

## Production Description:

PergoFlex is a combination between pergola and retractable awning, is designed especially to protect from the sun. The canvas is attached to a system of crossbar profiles with specially designed trolleys that move in guides systems within the outer profiles allowing horizontal sliding. It can operate with electric motor, manual motor and can also be moved manually.

## 产品描述:

PergoFlex是一种轨道天篷和伸缩遮阳篷的结合，专门设计以遮挡阳光。布料通过铝制的轨道移动开合。可通过电动电机，手动传动器，或者手动操作。

## 产品用途:

- 酒吧街、星级酒店、星级餐厅、豪华别墅区等高端商业场所；
- 泳池、花园、露台等私人豪华住宅区；
- 园林配套设施工程等。

# PERGOFLEX TO-940

## General Technical System Drawing

PERGOLAS  
室外电动天篷帘系列  
通用结构系统图

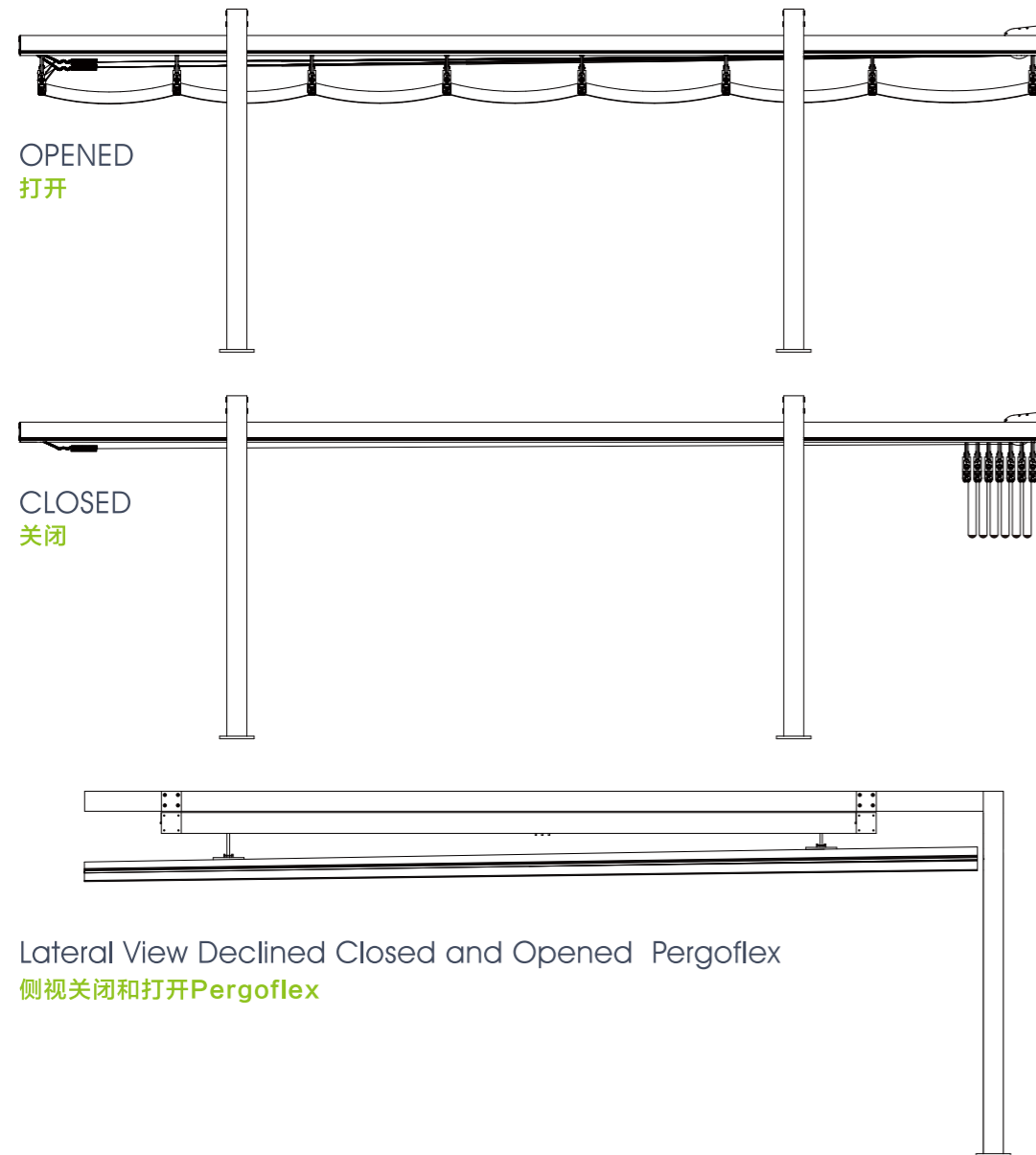

Measure of Pillars  
铝材尺寸

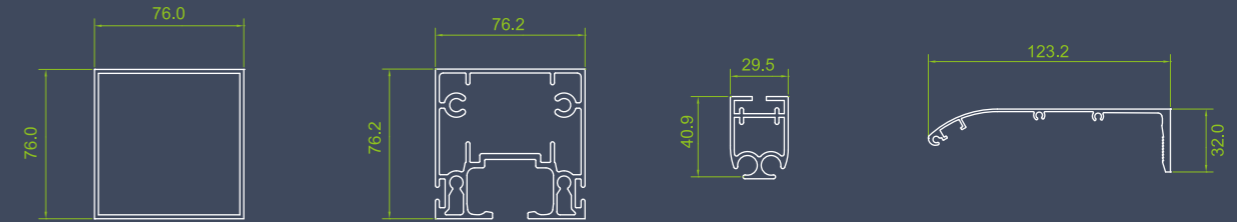

Fixation Elements  
固定元件



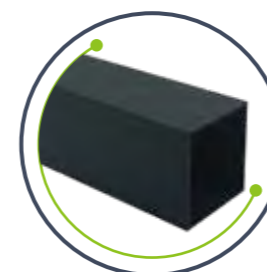
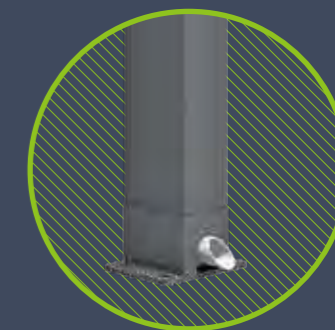
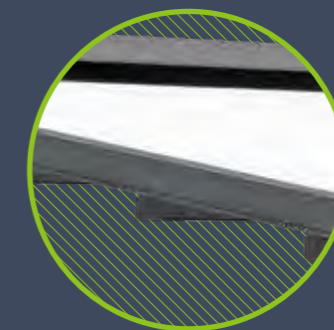
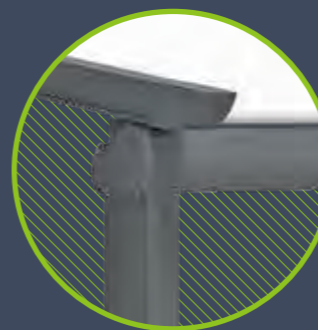

Beam



Rail

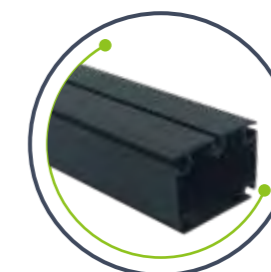

Big hanging fabric bar

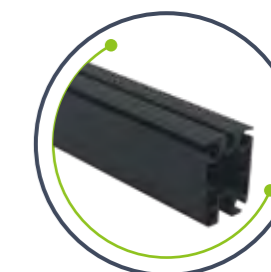

small hanging fabric bar

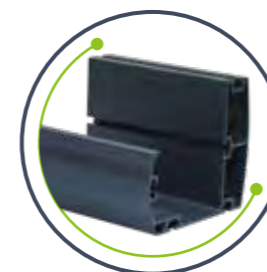

Gutter

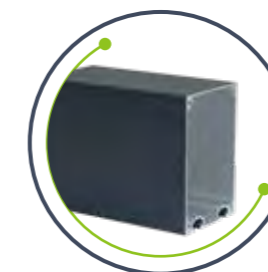

Post

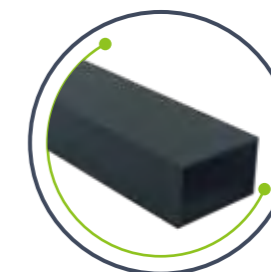

Rectangle alu profile

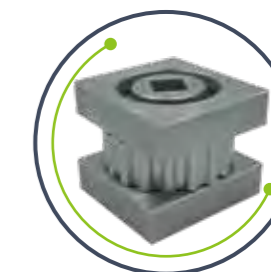

Belt rear bearing

## Production Description:

PergoTek is a combination pergola and retractable awning, which is tensioned when it is open. The canvas is attached to a system of transverse profile aluminum, which slide along a horizontal rail by specially designed trolleys. It operates with an electric torque motor designed specifically for this product. Guaranteed to with-stand severe climatic changes and winds up to 50 km / h (the resistance is not guaranteed under the weight of snow).

## 产品描述:

Pergotek是一种轨道天篷和伸缩遮阳篷的结合。布料通过特制的电机随铝制轨道伸缩移动，打开时可让客户感受大自然的阳光与空气，闭合后可以100%防水并有效遮挡阳光。产品能最低承受50km/h的风力。可根据现场定制出属于你的弧形美。

## 产品用途:

- 酒吧街、星级酒店、星级餐厅、豪华别墅区等高端商业场所;
- 泳池、花园、露台等私人豪华住宅区;
- 园林配套设施工程等。

# PERGOTEK TO-960

## General Technical System Drawing

PERGOLAS  
室外电动天篷帘系列  
通用结构系统图

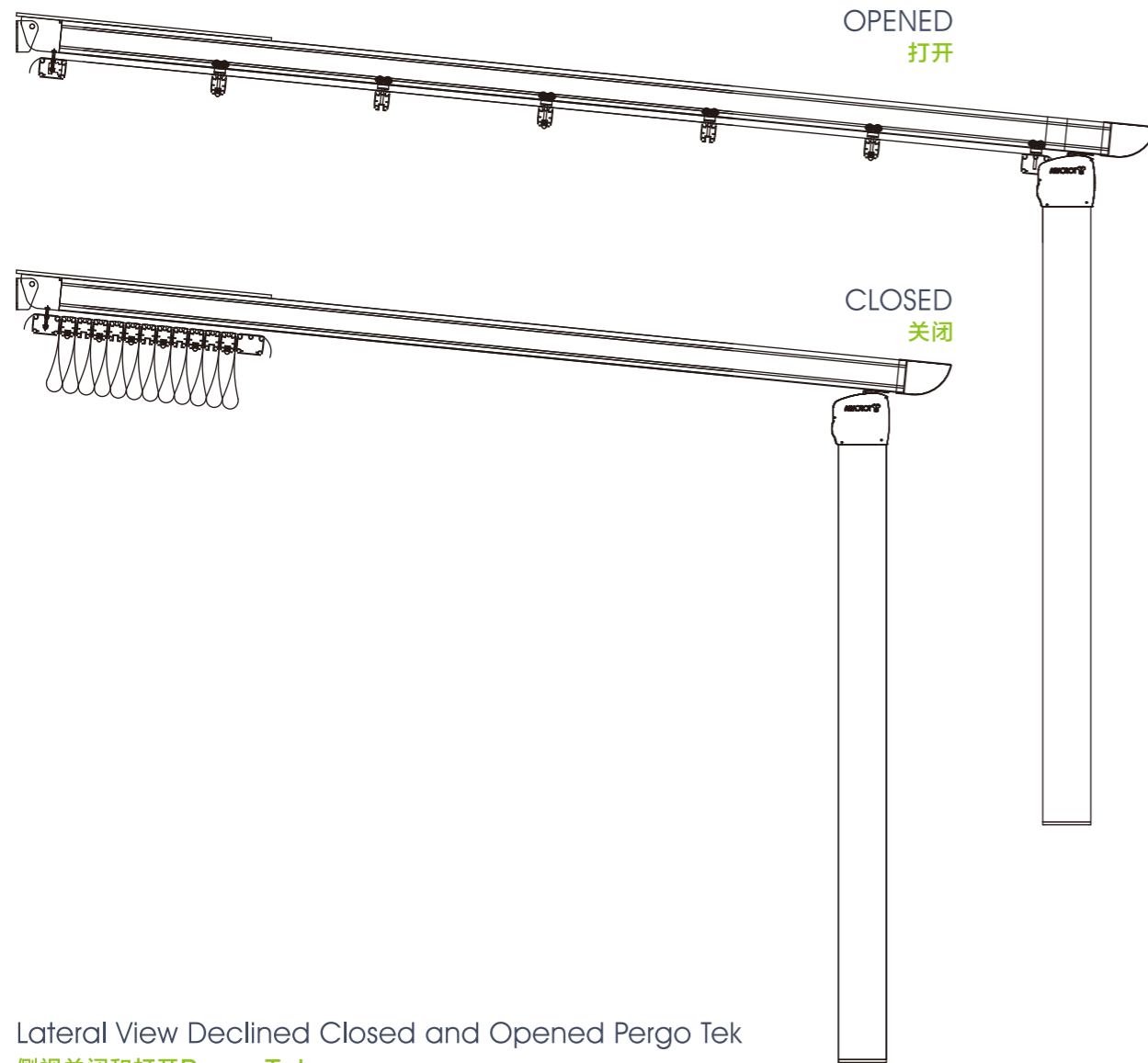

Lateral View Declined Closed and Opened Pergo Tek  
侧视关闭和打开Pergo Tek

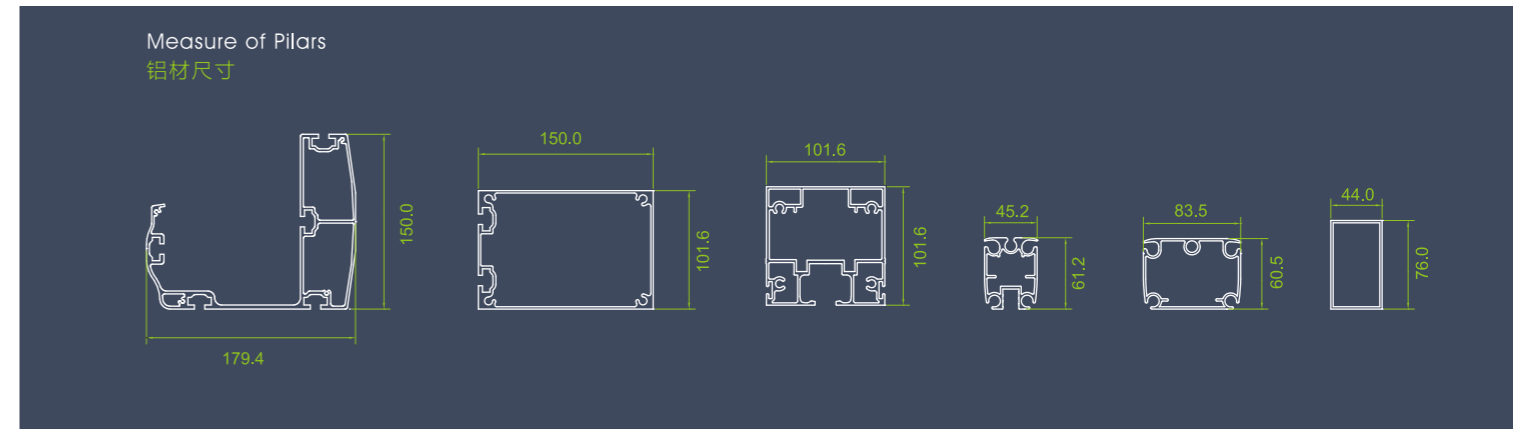

Articulated Wall Fixation Piece  
铰接式墙固定件

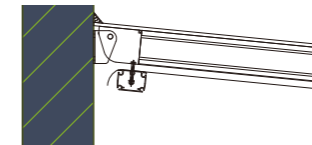

Articulated Roof Fixation Piece  
铰接式屋顶固定件

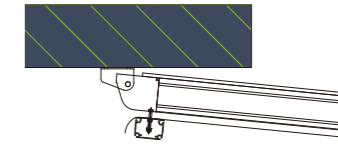

Fixation Elements  
固定元件

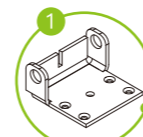

Rail bracket



Pillar fixation

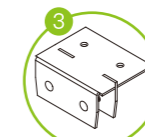

Rectangle alu profile bracket



Fastening bracket



Wall fixation



Rail fixation cap



Wall fixation bracket



Beam fastening bracket



Ground Fixation

PERGOTEK

# NEW PERGLAM TO-981

室外电动百叶翻板

PERGOLAS

室外电动天篷帘系列

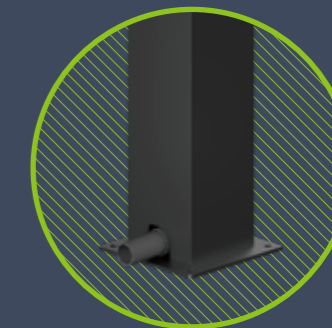
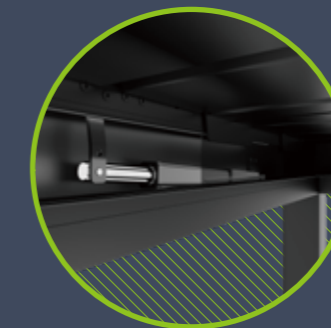
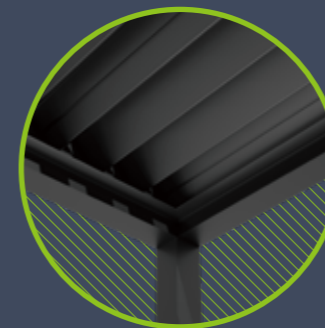

PERGLAM

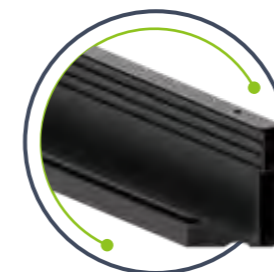

Beam & Gutter integrated

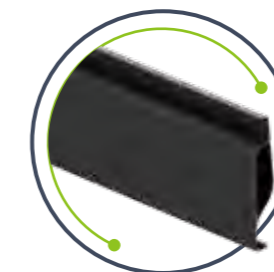

Louver

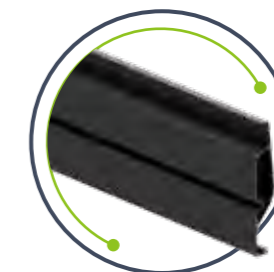

LED-Louver

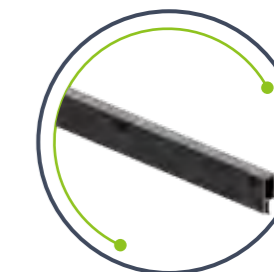

Driving rod

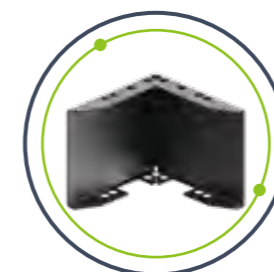

Big L shape beam connect part

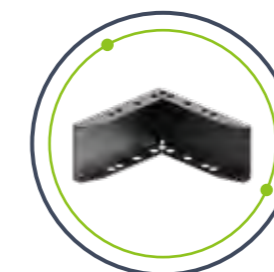

Small L shape beam connect part

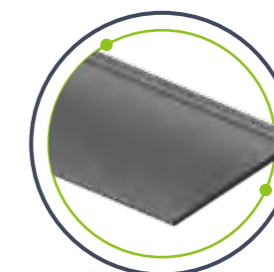

Small waterproof plate

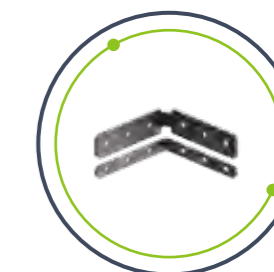

Connect part

## Production Description:

luxury pergola is a bioclimatic pergola that is entirely constructed with aluminum profiles. Thanks to its 27 cm wide louvers, when opened, it allows light and breeze to pass through, creating a greater sense of openness. It features a continuous or step-by-step rotation system of 0°, 50°, 100° and 150°. When closed, it is completely airtight, preventing the passage of light and water.

## 产品描述:

豪华凉篷是一个完全由铝型材建造的生物气候凉棚。得益于27厘米宽的百叶窗，打开时，光线和微风可以穿过，营造出更大的开放感。它具有0°、50°、100°和150°连续或逐步旋转系统。关闭时，它完全气密，防光，防水。

# NEW PERGLAM TO-981

## General Technical System Drawing

PERGOLAS  
室外电动天篷帘系列  
通用结构系统图

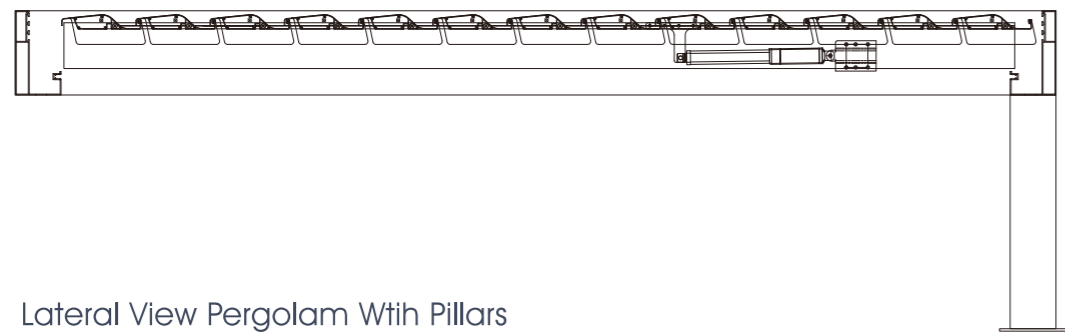
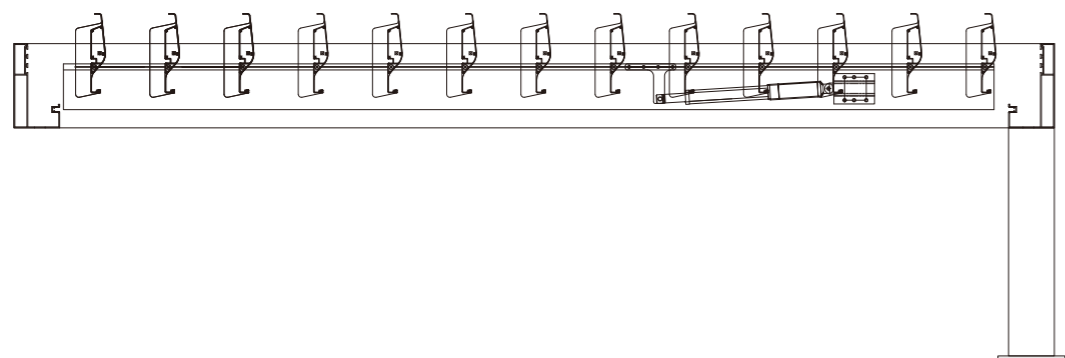
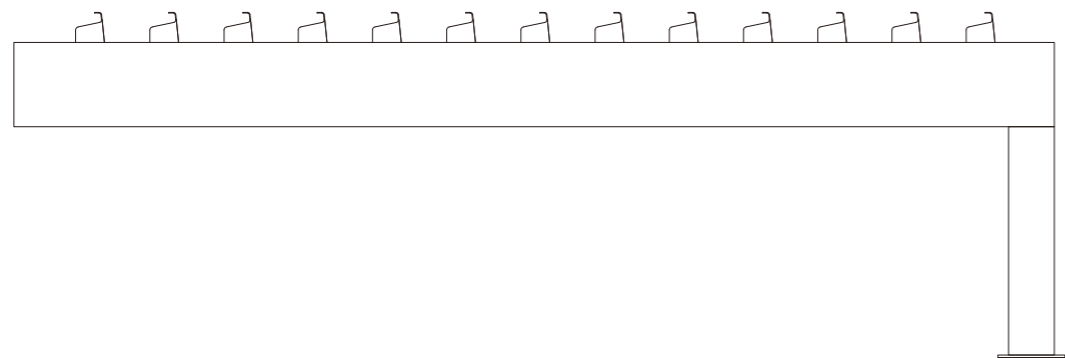

Lateral View Pergolam With Pillars  
前支柱Pergolam侧面

### Measure of Pillars 铝材尺寸

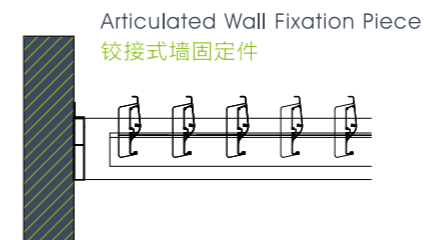
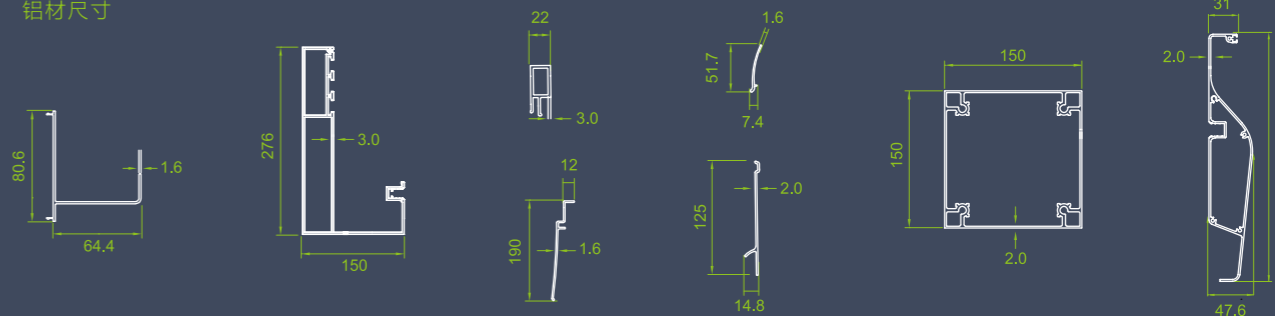

Articulated Wall Fixation Piece  
铰接式墙固定件

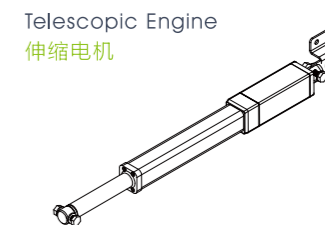

Telescopic Engine  
伸缩电机

### Fixation Elements 固定元件



Big L shape  
beam connectpart

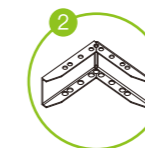

Small L shape  
beam connect part



Axle sleeve up cap  
with axle sleeve



Driving kit



Motor fastening  
bracket



50 Clip

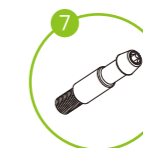

louver axis

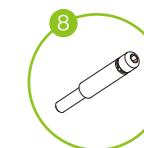

louver bolt

# CLASSIC PERGOLAM TO-980

室外电动百叶翻板

PERGOLAS

室外电动天篷帘系列

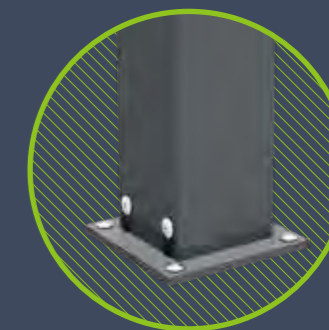
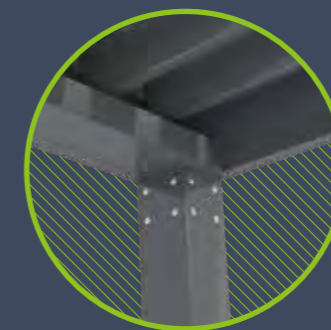
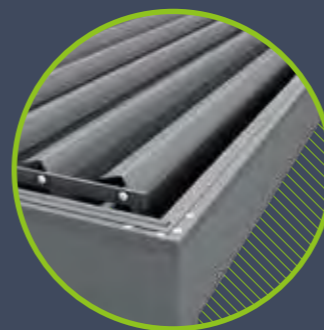
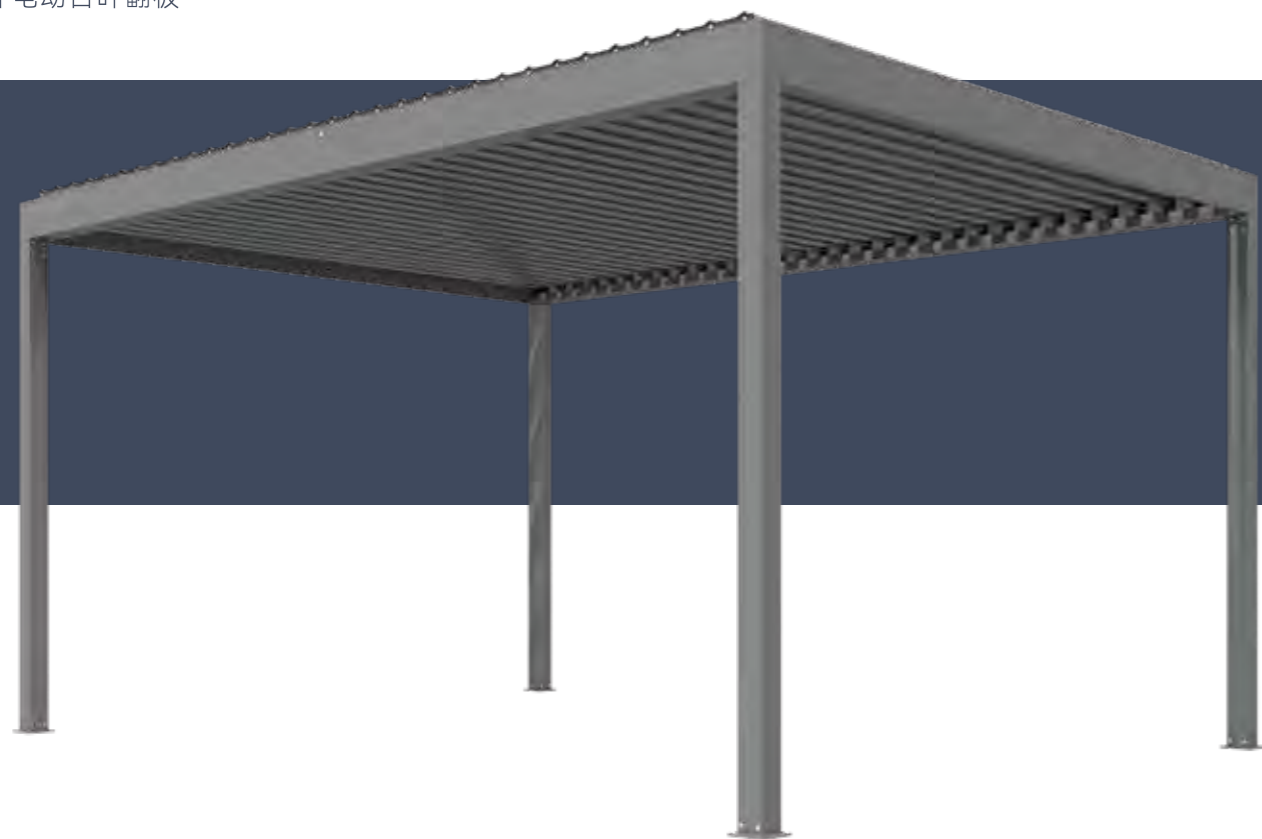

PERGOLAM

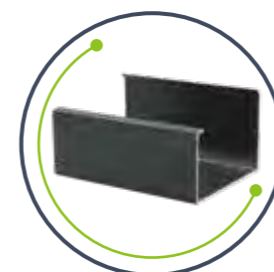

Gutter

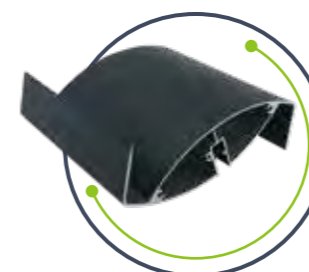

Louver

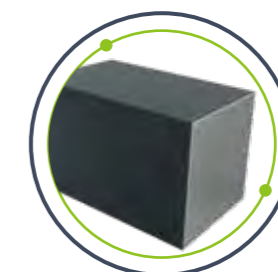

Post

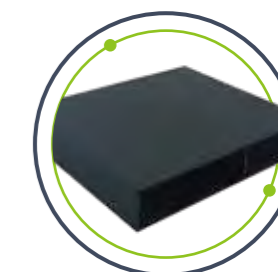

Beam

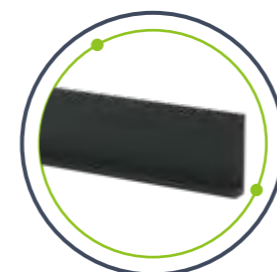

Driving alu profile



Corner union



Ground articulation



Motor fastening bracket

## Production Description:

PergoLam is a combination between pergola and horizontal louver which is completely made of aluminum and allows light and breeze when open. Using an electric telescopic engine connection system through parts and aluminum extrusions specially designed, the slats are closed completely sealed preventing the passage of light and water. When closed the slats become channels that carry the water to the sides that have their own system of canals and water should turn towards the poles where it drains. Guaranteed to withstand severe climatic changes and winds of up to 100 km/h. (The resistance is not guaranteed under the weight of snow).

## 产品描述:

PergoLam是一种轨道天篷和水平百叶帘等结合。由全铝制做，当页板打开后，允许光线和微风进入。当通过伸缩电机将铝制百叶板闭合后，能完全阻隔光线和雨水进入。雨水通过特殊设计当导水槽进入水管排出。产品能抵御恶劣气候和环境，最低承受100km/h当风力（在未积雪当情况下）。

## 产品用途:

● 星级酒店、星级餐厅、豪华别墅区等商业场所；● 泳池、花园、楼顶等私人豪华住宅区。

# CLASSIC PERGOLAM TO-980

## General Technical System Drawing

PERGOLAS  
室外电动天篷帘系列  
通用结构系统图

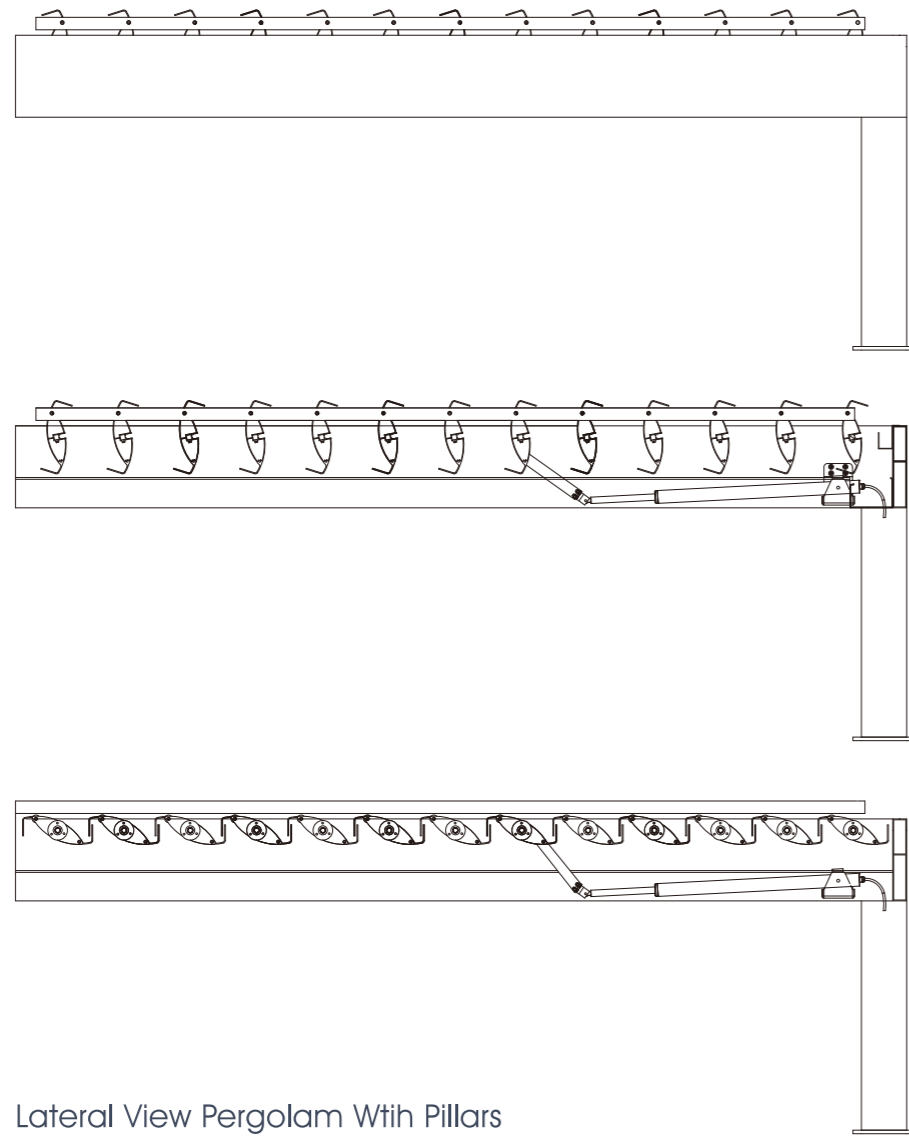

Lateral View Pergolam With Pillars  
前支柱Pergolam侧面

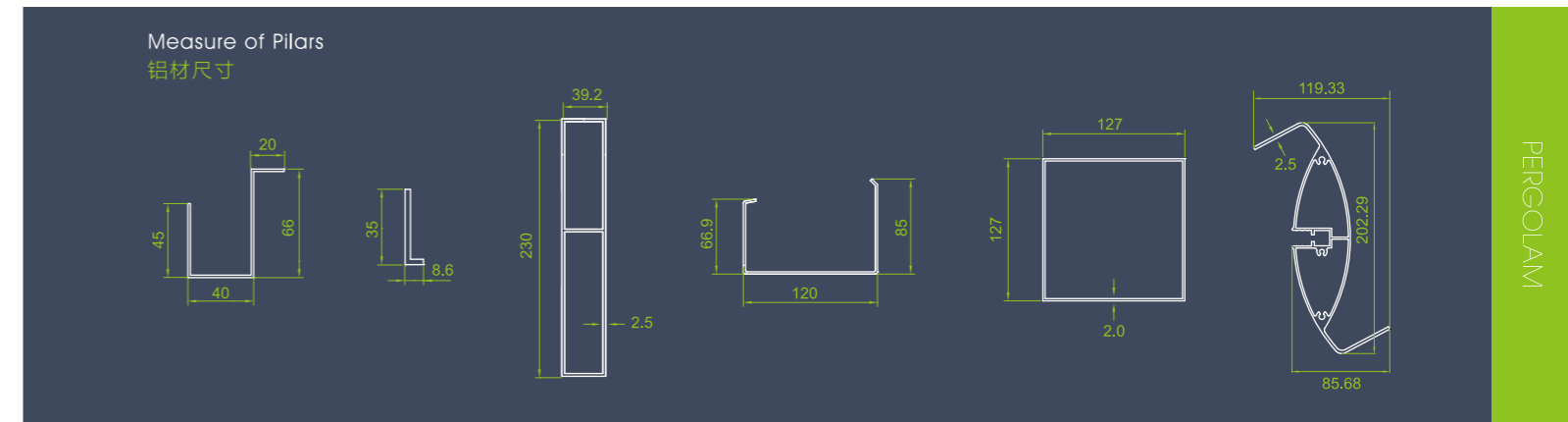

PERGOLAM

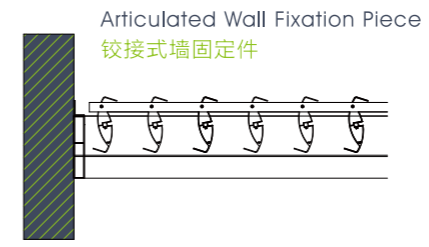

Articulated Wall Fixation Piece  
铰接式墙固定件

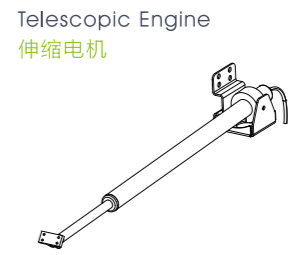

Telescopic Engine  
伸缩电机

### Fixation Elements 固定元件

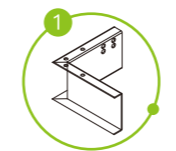

Big corner union

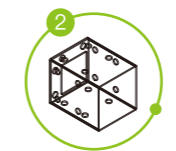

Universal fastening bracket

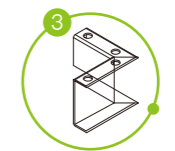

Small corner union



Motor fastening plate



Motor fastening bracket



Ground articulation

# GR-910A Manual Zip Screen

拉链垂直帘

PERGOLAS

室外电动天篷帘系列

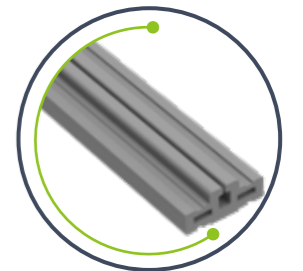
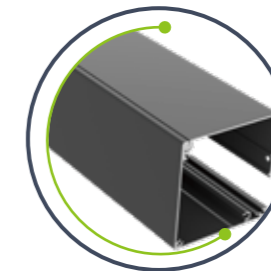
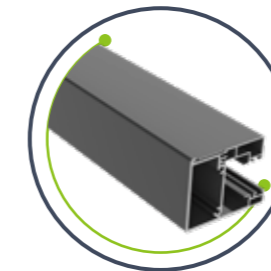
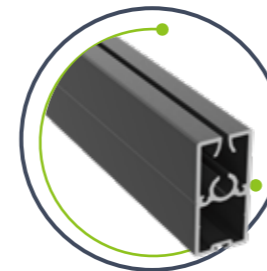
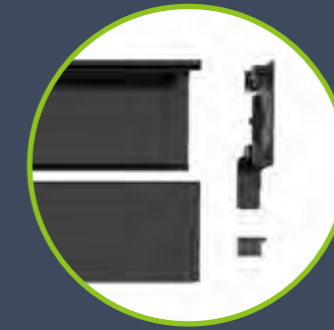
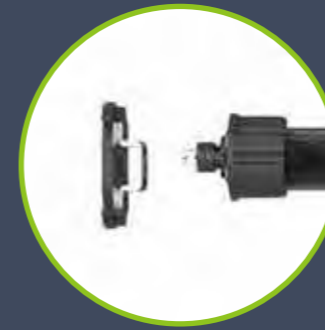
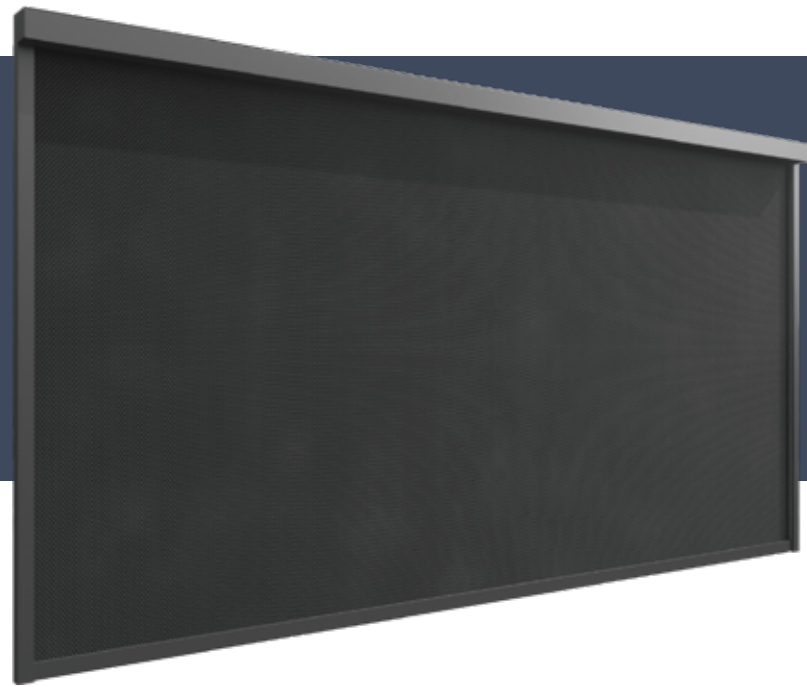

Bottom rail

Side rail

Cover box

Zipper guide

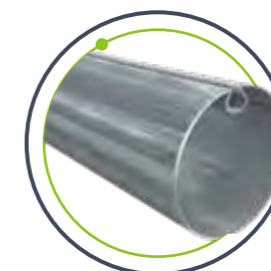

Tail-end mount

Ø 70 Galvanized tube

Cap

## Production Description:

The manual screen uses internal high-quality springs to control the extension of the screen, which is convenient for end customers to use, easy to install and simple to operate.

## 产品描述:

手动垂直帘，采用内部优质弹簧控制帘的伸出，方便终端客户使用，安装方便，操作简单。

Cassette	100 x 100 x 1.6mm
Side Rail	49 x 39 x 1.6mm
Bottom Rail	45 x 25.4 x 1.5mm
Spring	2.6mm /3.3mm

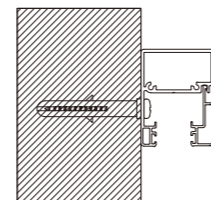
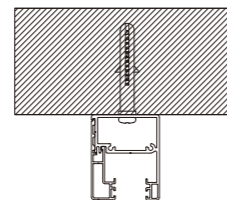

# GR-910B Motorized Zip Screen

拉链垂直帘

PERGOLAS

室外电动天篷帘系列

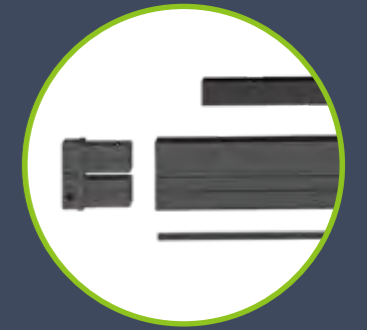
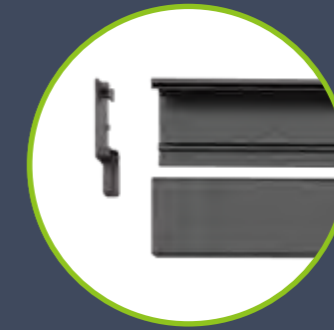

GR910B

## Production Description:

The motorised screen acts as a screen and it can reach outdoor powder coating standard and can be matched with three large outdoor sunshade products; Provide a variety of fabric choices, such as acrylic fabric imported from Spain, sunshine fabric, etc. It has good ventilation and breathability, and is the preferred material for screens and other materials. The unique zipper design uses imported sewing and German imported knives to achieve perfect edge sealing and closing.

Cassette	100 x 100 x 1.6mm
Side Rail	49 x 39 x 1.6mm
Bottom Rail	45 x 25.4 x 1.5mm

## 产品描述:

电动密封垂直帘充当屏风作用，户外烤漆标准，与三款大型室外遮阳产品皆可配套。提供多种面料选择，如西班牙进口亚克力面料，阳光面料等。通风透气性好，是屏风等优选有料。特色拉链设计，采用进口缝纫与德国进口刀具，完美封边与收合。

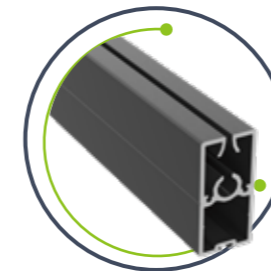
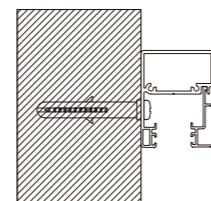
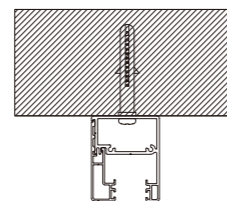

Bottom rail

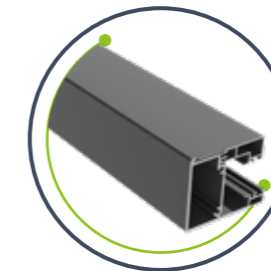

Side rail

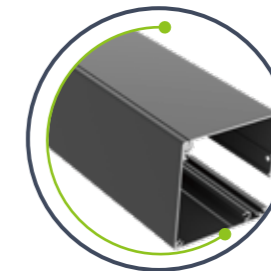

Cover box

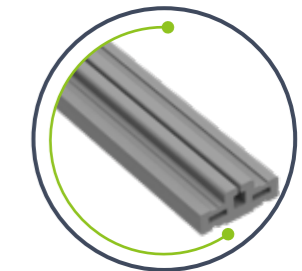

Zipper guide



Tail-end mount

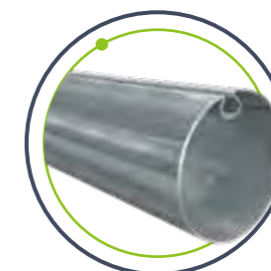

Ø 70 Galvanized tube



Cap



## FLEXIZIPP

Motorized roller blind, made to order, offering a personalized service of excellent quality.

The structure is in anodized aluminum and its protection can be in imported acrylic canvas Dickson brand, mesh type Batyline and the possibility of having appliques in clear or translucent according to the request of the client; Can be manufactured in different colors.



## FLEXIGLASS

FlexiGlass Classic is a system of glass curtains, formed by independent sheets that slide with a rolling mechanism, achieving a total opening, when collected in one or several ends.

The weight of the glasses of this system is in the upper guide of the structure.



## FLEXIWIND

Windbreak window with structure in anodized aluminum, it has two bodies one fixed and another that slides offering to increase the protection against the inclemency of the weather and that can be closed when this is no longer necessary.



## PERGOLEDS

LED lighting system unique in the market since the LED neon and spot are completely uniform in its transmission of light and the energy consumption of this product is minimum generating savings for our clients in its invoices, this product can be used with a dimmer to control the intensity of the light.

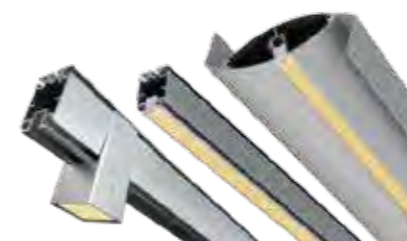

## PERGOCOOL

Water sprinkler that can be installed in products such as PergoLam and PergoTek, this one has a central computer that is responsible for timing the nebulization and allows scheduling of the sprinkler cycles offering a refreshing environment.



## PERGOHEAT

High-tech remote-controlled heating system, which allows the generation of warm spaces, quickly and very efficiently, with the great advantage of handling a low-frequency wave.





# UNIVERSAL PARTS

通用配件

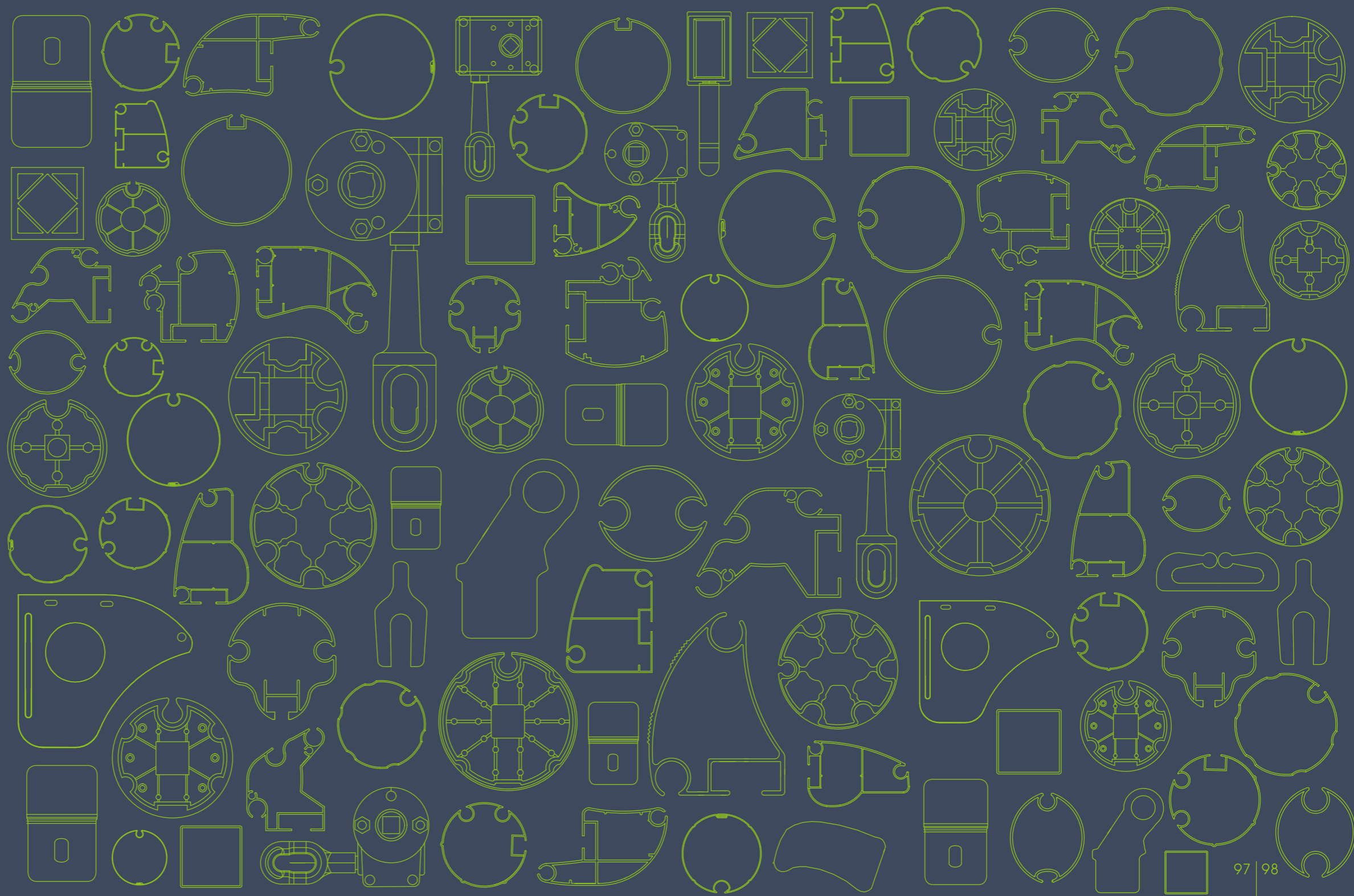

# UNIVERSAL PARTS

通用配件

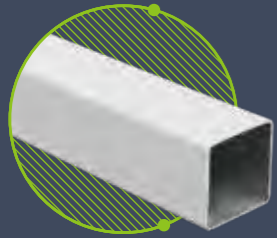

Steel Square Bar  
35x35x1mm

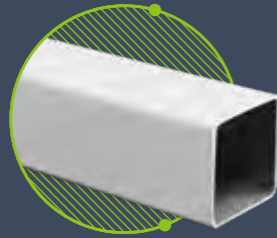

Steel Square Bar  
40x40x1.5mm

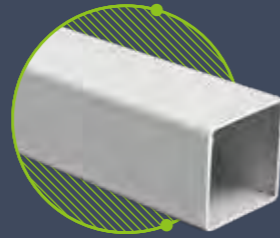

Steel Square Bar  
40x40x2mm

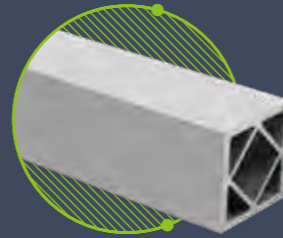

Aluminum Square Bar  
40x40x3.3mm

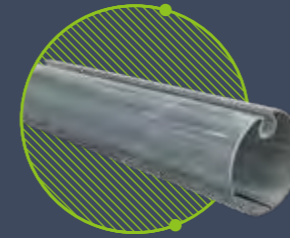

Ø 35mm Galvanized Tube

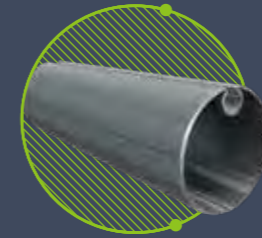

Ø 48mm Galvanized Tube

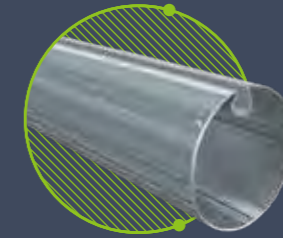

Ø 60mm Galvanized Tube

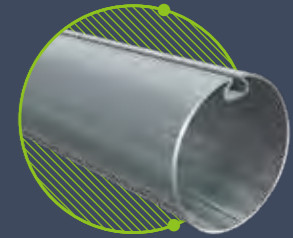

Ø 63mm Galvanized Tube

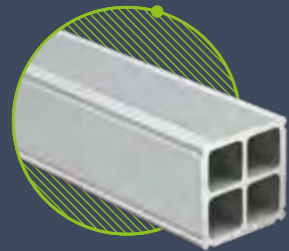

Aluminum Bar Joint for  
40x40mm Square Bar

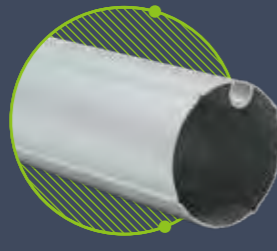

Ø 50mm Aluminum Tube

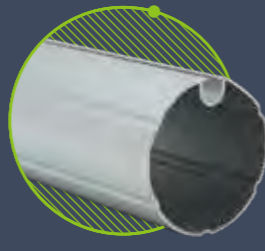

Ø 60mm Aluminum Tube

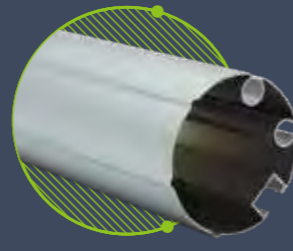

Ø 65mm Aluminum Tube

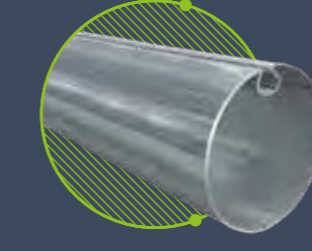

Ø 70mm Galvanized Tube

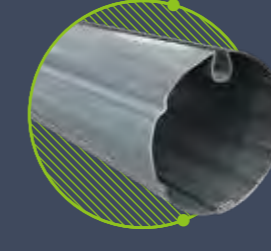

Ø 70mm Galvanized Tube

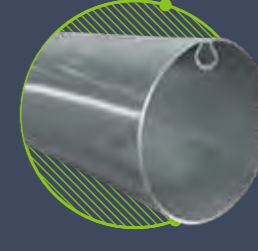

Ø 78mm Galvanized Tube

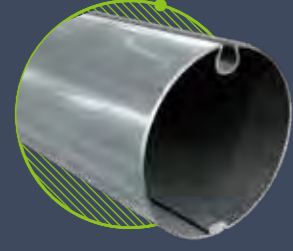

Ø 78mm Galvanized Tube

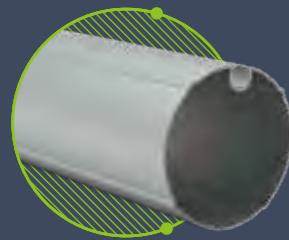

Ø 70mm Aluminum Tube

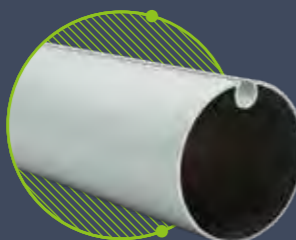

Ø 78mm Aluminum Tube

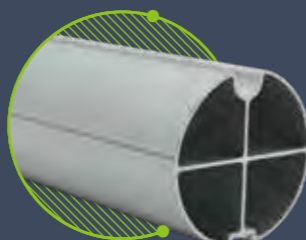

Ø 85mm Tube Joint

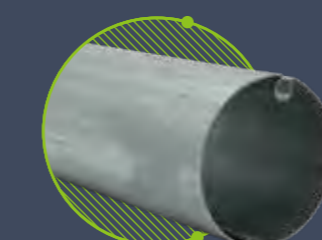

Ø 85mm Galvanized Tube

# UNIVERSAL PARTS

通用配件

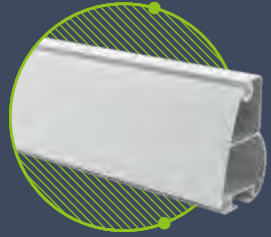

0263 Front Bar

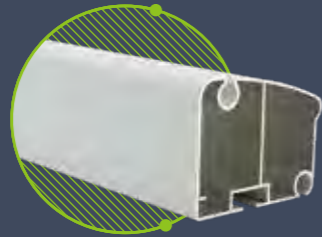

740 Front Bar

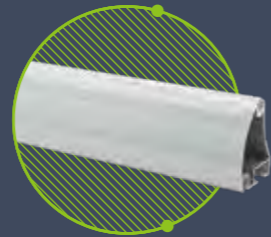

22003B Front Bar

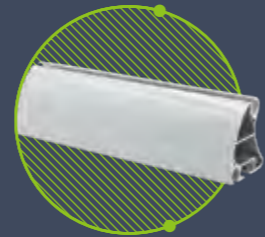

22003 Front Bar

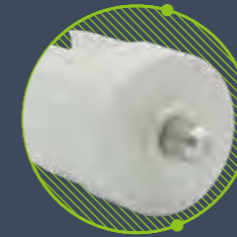

Ø 50mm Tube plug round pin



Ø 50mm Tube plug square pin

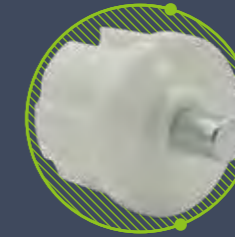

Ø 60mm Tube Plug Round Pin

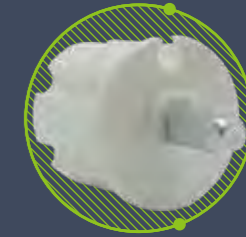

Ø 60mm Tube Plug Square Pin

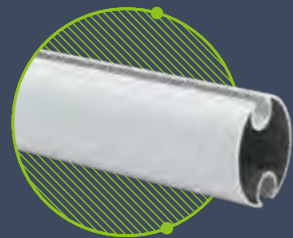

50007 Front Bar

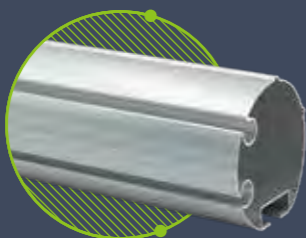

Aluminum Front Tube

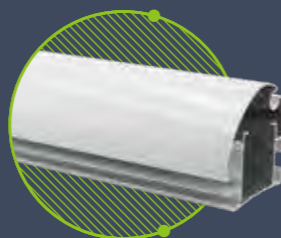

67003 Front bar D

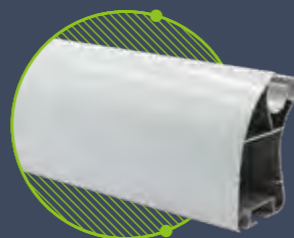

66003 Front bar

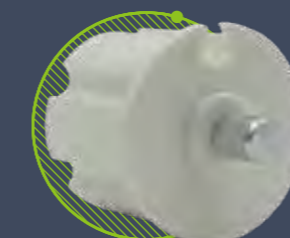

Ø 70mm Tube Plug Round Pin

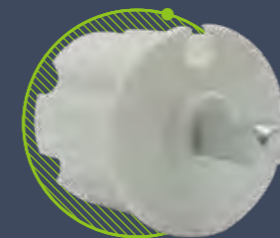

Ø 70mm Tube Plug Square Pin

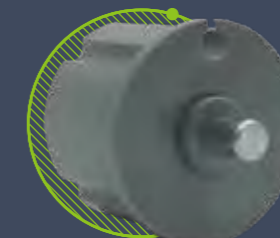

Ø 78mm Tube Plug Round Pin

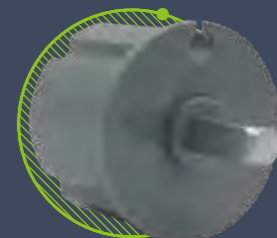

Ø 78mm Tube Plug Square Pin

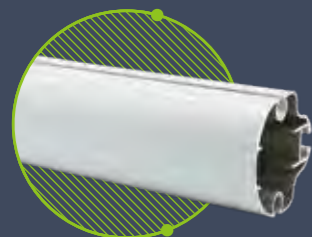

51003 Front bar of drop arm awning

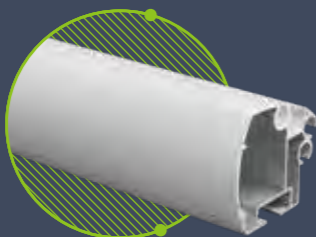

55003B Front Bar

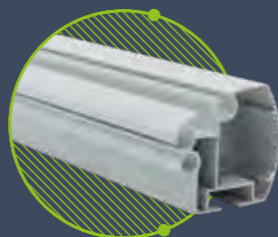

55003B Front Bar

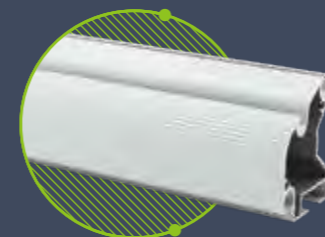

A06 Front Bar



Ø 85mm Tube Plug Round Pin

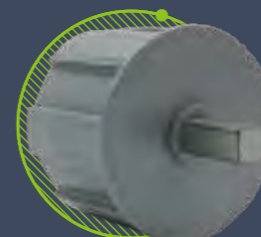

Ø 85mm Tube Plug Square Pin

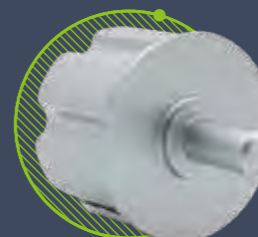

Ø 70mm Tube Plug Round Pin (Aluminum)

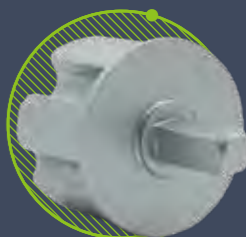

Ø 70mm Tube Plug Square Pin (Aluminum)

# UNIVERSAL PARTS

通用配件

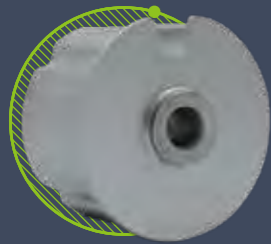

Ø 70mm Hollow Plug

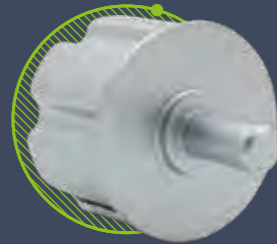

Ø 80mm Tube Plug  
Round Pin (Aluminum)

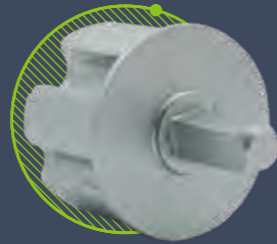

Ø 80mm Tube Plug  
Square Pin (Aluminum)



Ø 85mm Aluminum Tube  
Plug Round Pin

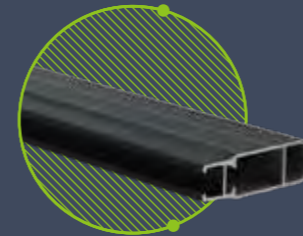

Aluminum profile B

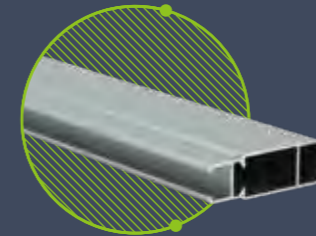

Aluminum profile A

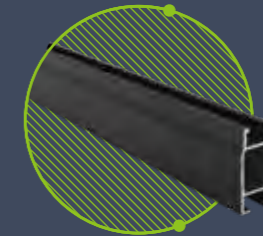

Aluminum Profile C



Aluminum Elbow Connector

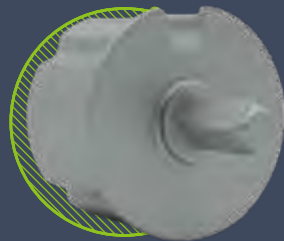

Ø 85mm Square Pin

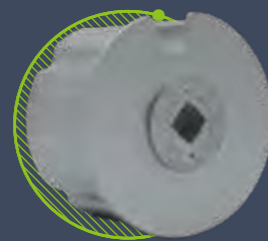

Ø 85mm Hollow Plug



Steel Ceiling Bracket

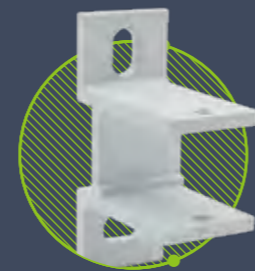

Aluminum Wall Bracket 35mm



Plastic Elbow Connector



4 Hinge Connector



33001 Connector (two feet)



33001 Connector (one feet)

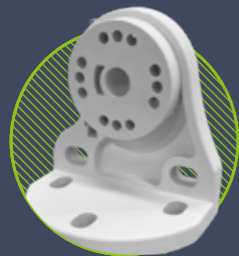

Aluminum Side Bracket (R)

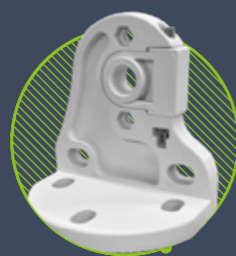

Aluminum Side Bracket (L)



Aluminum Side Bracket

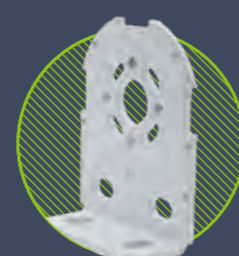

Steel Side Bracket Big

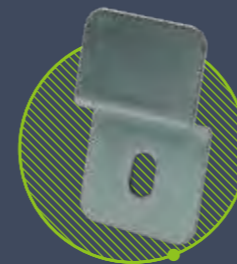

31001 Bracket



31004 Y Permanent Yard



Right Angle Connector



Hung Wheel

# UNIVERSAL PARTS

通用配件



Hung Wheel C



4 Hinge Connector C

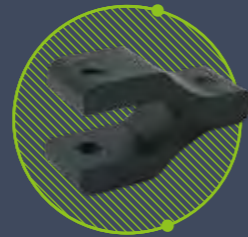

Y Fixing Part C



66018 Central support

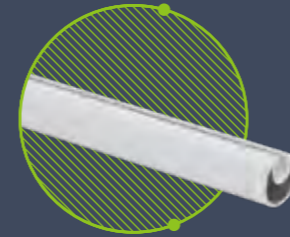

Valance Tube

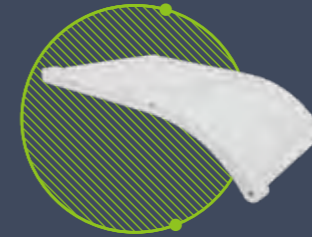

Flashing

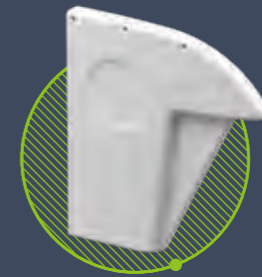

Flashing Side Cap

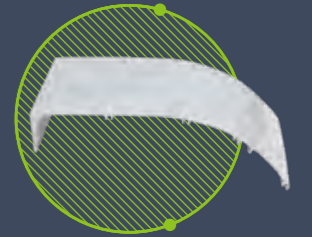

Flashing



Aluminum Elbow Connector C

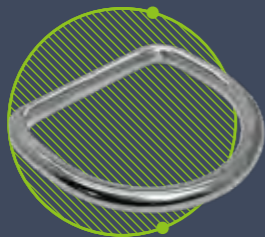

316 D-shape

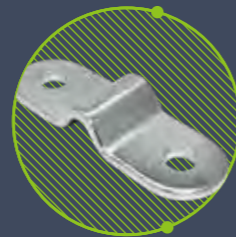

316 Ground hook (Small)

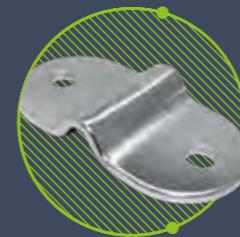

316 Ground hook (Big)



67008 Aluminum support cap

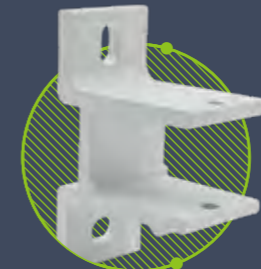

Aluminum Wall Bracket 40mm



Aluminum F Bracket



Aluminum Ceiling Bracket



316 Hook



316 Arch part 5mm



316 Hook with base

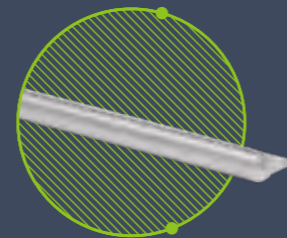

Press Tube



1: 7 Gear Box



1: 11 Gear Box



1: 11 Gear Box



1: 16 Gear Box

UNIVERSAL PARTS

# MOTOR/HAND CRANK

电机/摇杆

Standard, Mechanic Limit, 10N.m

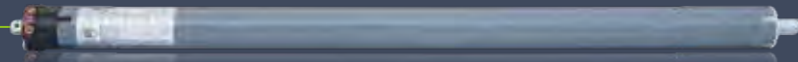

Standard, Mechanic Limit, 50N.m



Manual Radio, Mechanic Limit + Built-in Receiver + Manual Function + Dot-move & light-adjust function, 50N.m



Standard, Mechanic Limit, 100N.m



Manual Radio, Mechanic Limit + Built-in Receiver + Manual Function + Dot-move & light-adjust function, 100N.m



Wind-Sun Sensor



Five-channel Emitter

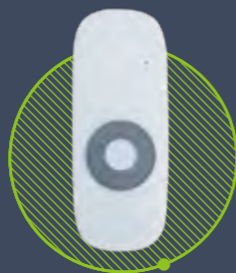

Single-channel Emitter



Five-channel Emitter



Single-channel Emitter

## ACCESSORIES

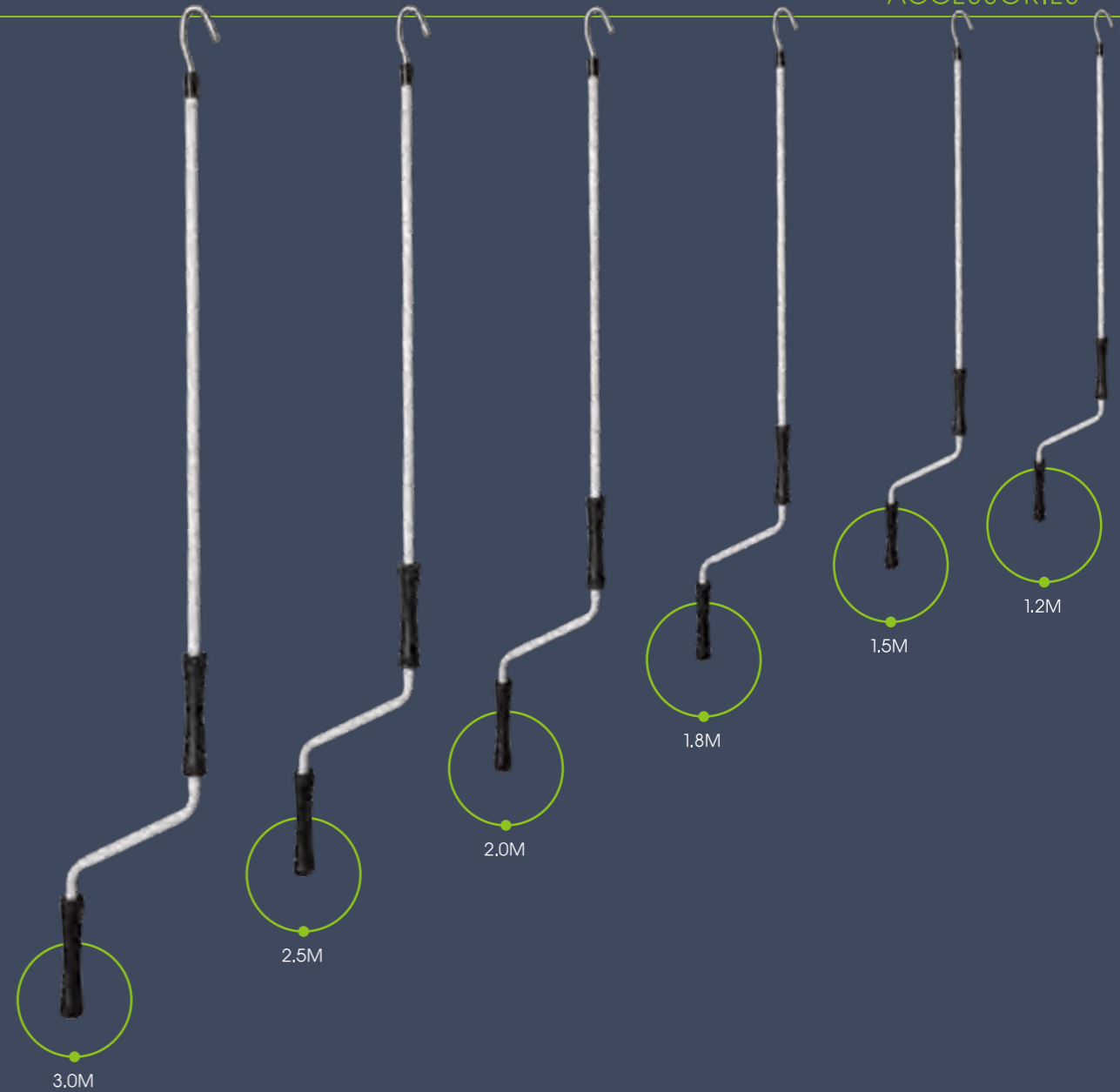

MOTOR/HAND CRANK

# SPANISH ACRYLIC FABRIC

# HOME-MADE ACRYLIC FABRIC

# AWNING FABRIC

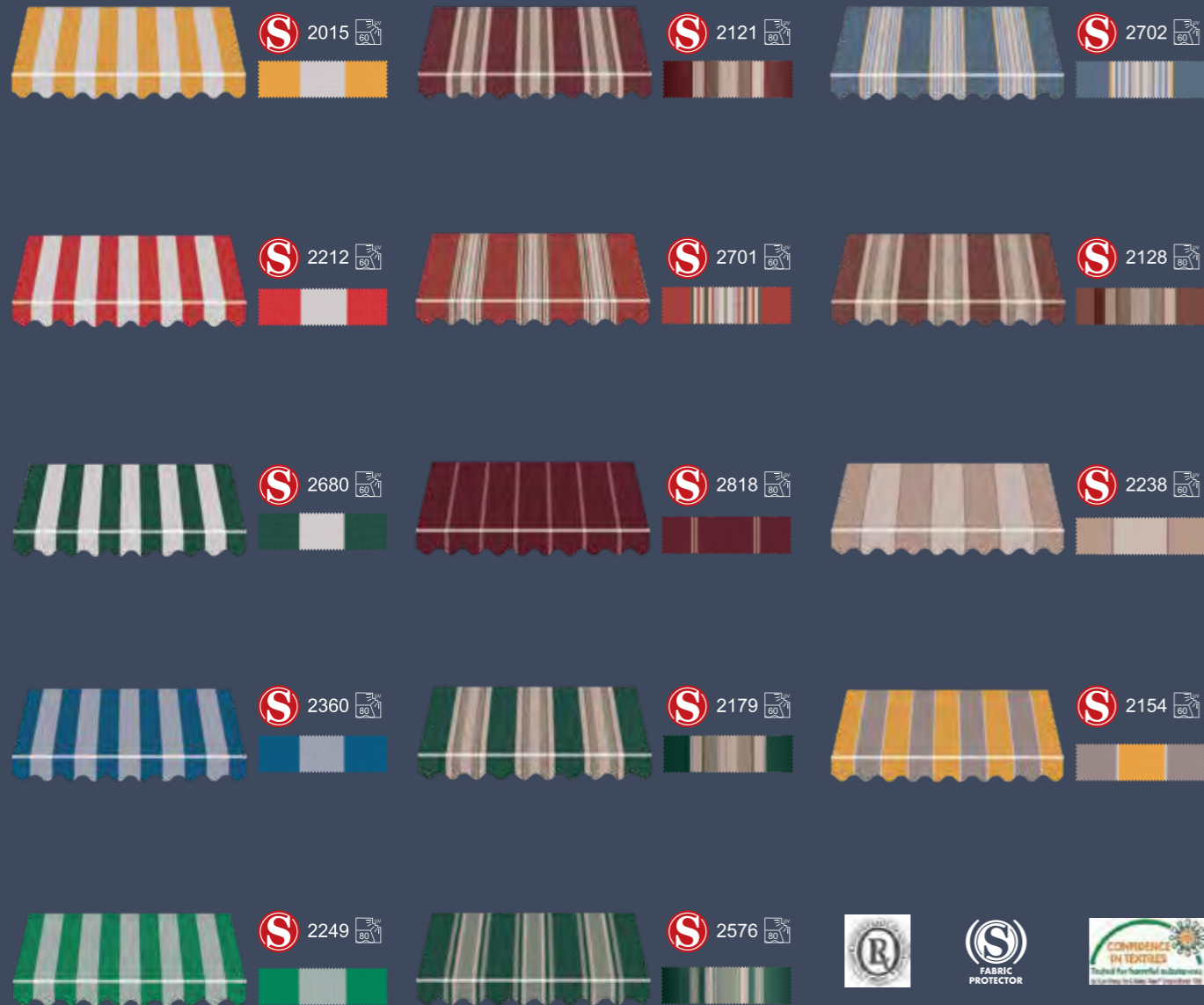

AWNING FABRIC