

P07-08	 DP-388LLi M-SI/DO	 DP-3888LLi M-SI/DO	 DP-8081LLi M
P08-09	 DP-3338LLi M24	 DP-5/2WLLi comb24	 DP-NM3/40L/Li/65/24
P09-10	 DP-8081LLi NM	 SAX3HF100VLLi-15&30MAH	 DP-918LLi M
P11-12	 DP-696LLi NM-1500	 DP-699LLi NM24	 DP-666LLi M
P12-13	 DP-660LLi M	 DP-5WLLi NM-ZD	 DP-7/5/2WLLi M-P24-2
P14-15	 DP-5WLLi NM26	 DP-6668LLi M	 DP-8016LLi NM
P15-16	 DP-8022LLi NM	 DP-8026LLi NM	 DP-8066LLi NM
P16	 DP-8038LLi NM		

Emergency Bulkhead

P17-18	 DP-689LLi M24	 DP-688LLi M24	 DP-629LLi M24
P18-19	 DP-628LLi M24	 DP-641LLi M24	 DP-608LLi M24
P19	 DP-630LLi M24	 DP-618LLi M24	 DP-638L M

 DP-638LBl M24	 DP-668LLi M24	 DP-680LLi M24	P20
--	--	--	-----

Emergency Exit Sign

 DP-998LLi M24	 DP-955LLi M24	 DP-966LLi M24	P21-22
 DP-908LLi M	 DP-999LLi M24	 DP-938LLi M24	P22-23
 DP-939LLi M24	 DP-991LLi M24	 DP-933LLi M24	P23-24
 DP-922LLi M24	 DP-630LLiEXIT M24	 DP-989L M	P24-25
		 DP-9811&9822LLi M	P25

Emergency Exit Box

 DP-3229LLi M24	 DP-3218L M	 DP-3228LLi M24	P27-28
 DP-3288LLi M	 DP-318LLi M24	 DP-338LLi M24	P28-29
 DP-630LLi MT24	 DP-638LBl MT24	 DP-680LLi MT24	P30

Emergency Twinspot



Emergency Ceiling Light



Emergency Corridor Light



Emergency Downlight



Emergency Pack



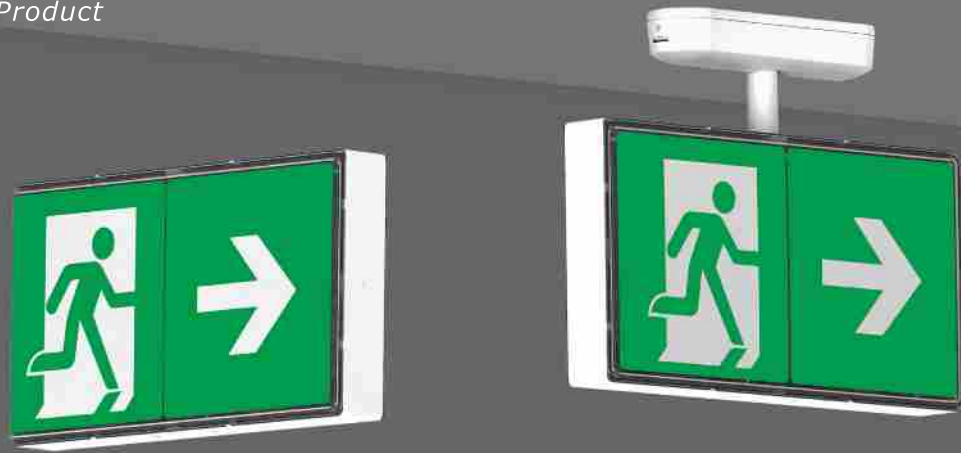

DP-388LLi M-SI&DO

- Transparent PC housing
- Single-sided/Double-sided
- Exit box with downlight
- IP65

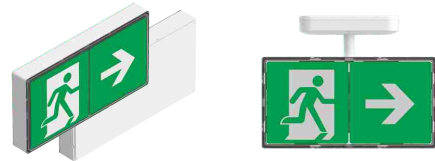

Model	Input Voltage	Battery	Charging / Fully charged	Visible Distance	Charge / Discharge	Size (mm)	Optional
DP-388LLi M-SI	220-240VAC	3.2V 2.0Ah LiFePO4	2.5W / 3.0W	32m	24h / ≥3h	362x50x190	Self-test & DALI-2
DP-388LLi M-DO	220-240VAC	3.2V 2.0Ah LiFePO4	4.0W / 4.5W	32m	24h / ≥3h	362x50x190	Self-test & DALI-2



DP-388LLi M-SI&DO

- Metal housing and PC panel
- Single-sided/Double-sided
- Exit box with downlight

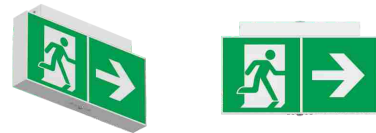
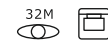

Model	Input Voltage	Battery	Charging / Fully charged	Visible Distance	Charge / Discharge	Size (mm)	Optional
DP-388LLi M-SI	220-240VAC	3.2V 2.0Ah LiFePO4	2.5W / 3.0W	32m	24h / ≥3h	374x50x216	Self-test & DALI-2
DP-388LLi M-DO	220-240VAC	3.2V 2.0Ah LiFePO4	4.0W / 4.5W	32m	24h / ≥3h	374x50x216	Self-test & DALI-2

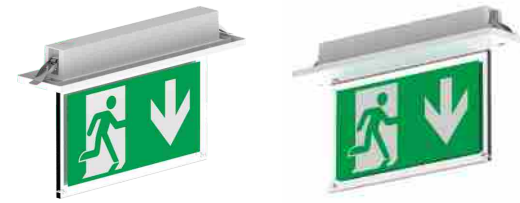

DP-8081LLi M

- 14pcs 2835 LEDs
- PC housing
- Recessed installation

Model	Input Voltage	Battery	Charging / Fully charged	Visible Distance	Charge / Discharge	Size (mm)	Optional
DP-8081LLi M	220-240VAC	3.2V 1.0Ah LiFePO4	2.0W / 2.5W	24m	24h / ≥3h	380x90x224	CBS & Self-test



DP-3338LLi M24

- Innovative rotatable plate design
- Ultra-thin housing, uniform light
- Exit box with downlight



Model	Input Voltage	Battery	Charging / Fully charged	Visible Distance	Charge / Discharge	Size (mm)	Optional
DP-3338LLi M24	220-240VAC	3.2V 1.0Ah LiFePO4	1.5W / 2.0W	24m	24h / ≥3h	325x187x30.5	CBS & Self-test

DP-5W/2WLLi comb 24

- Suitable for lamp head under 5 watts
- Integrated housing for PCB and battery

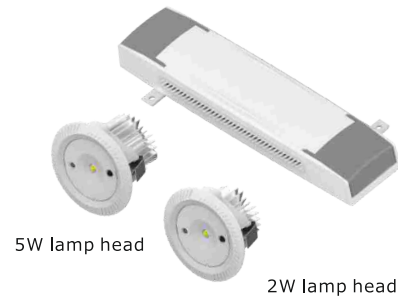

Model	Input Voltage	Battery	Charging / Fully charged	Luminous flux	Charge / Discharge	Size (mm)	Optional
DP-5WLLi M comb24	220-240VAC	3.2V 3.0Ah LiFePO4	3.0W / 3.5W	230/230lm (AC/DC)	24h / ≥3h	220x52x29 (PCB) Φ70x48 (5W Lamp)	CBS & Self-test
DP-2WLLi NM comb24	220-240VAC	3.2V 1.5Ah LiFePO4	2.0W / 0.5W	140lm (DC)	24h / ≥3h	Φ70x33 (2W Lamp)	Self-test



DP/NM3/40L/Li/65/24

- 40pcs Φ5 LEDs
- PC housing
- IP65



Model	Input Voltage	Battery	Charging / Fully charged	Luminous flux	Charge / Discharge	Size (mm)	Optional
DP/NM3/40L/Li/65/24	220-240VAC	3.2V 3.0Ah LiFePO4	2.5W / 0.5W	330lm (DC)	24h / ≥3h	297x89x281	Self-test

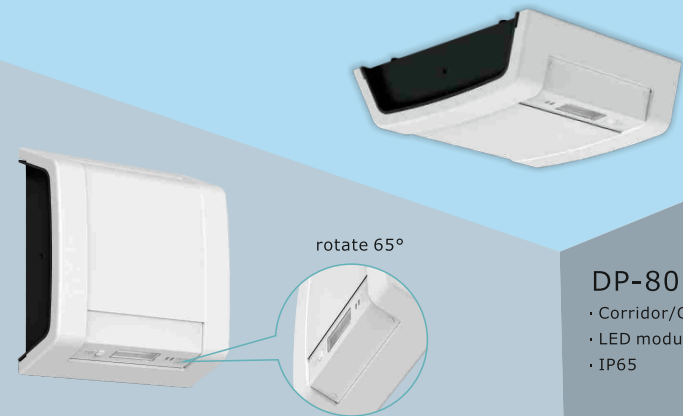

DP-8018LLi NM

- Corridor/Ceiling Light
- LED module rotated 65°
- IP65

Model	Input Voltage	Battery	Charging / Fully charged	Luminous flux	Charge / Discharge	Size (mm)	Optional
DP-8018LLi NM	220-240VAC	3.2V 1.5Ah LiFePO4	1.5W / 0.5W	85lm (DC)	24h / ≥3h	140x135x42	Self-test

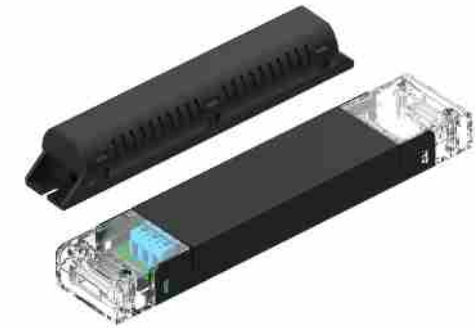

SAX3HF100VLLi-15MAH/30MAH

- Adapt to load LED light source 10-100W
- Output current 20mA (15MAH)/40mA (30MAH)

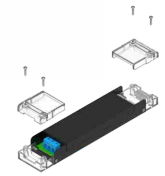
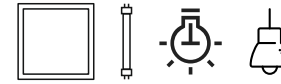

Model	Input Voltage	Battery	Charging / Fully charged	Charge / Discharge	Size (mm)	Optional
SAX3HF100VLLi-15MAH	220-240VAC	6.4V 1.5Ah LiFePO4	2.5W / 0.5W	24h / ≥3h	211x44.5x22 (PCB) 160x29.5x26 (Battery)	Self-test
SAX3HF100VLLi-30MAH	220-240VAC	6.4V 3.0Ah LiFePO4	4.0W / 0.5W	24h / ≥3h	211x44.5x22 (PCB) 195x33x30 (Battery)	Self-test



DP-918LLi M

- Transparent frame, uniform light
- 5 installations for various environments
- LiFePO4 battery, long life time



DP-918LLi M-re

Model	Input Voltage	Battery	Charging / Fully charged	Visible Distance	Charge / Discharge	Size (mm)	Optional
DP-918LLi M	220-240VAC	3.2V 1.0Ah LiFePO4	2.0W / 2.5W	24m	24h / ≥3h	279x55x207.9	Self-test & DALI-2
DP-918LLi M-re	220-240VAC	3.2V 1.0Ah LiFePO4	2.0W / 2.5W	24m	24h / ≥3h	279x125x224	Self-test & DALI-2



DP-696LLi NM-1500

- Bulkhead, IP66
- 81pcs 5730 LEDs
- 1500lm (DC)

Model	Input Voltage	Battery	Charging / Fully charged	Luminous flux	Charge / Discharge	Size (mm)	Optional
DP-696LLi NM-1500	220-240VAC	6.4V 5.5Ah LiFePO4	3.5W / 0.5W	1500lm (DC)	24h / ≥3h	320x165x74	Self-test & DALI-2

DP-666LLi M

- Bulkhead, IP66
- 4pcs 3030 LED (with lenses)
- PC legend



Model	Input Voltage	Battery	Charging / Fully charged	Luminous flux	Charge / Discharge	Size (mm)	Optional
DP-666LLi M	220-240VAC	3.2V 3.0Ah LiFePO4	3.0W / 3.5W	320/300lm (AC/DC)	24h / ≥3h	255x64.5x120	CBS & Self-test

DP-660LLi M

- Bulkhead, IP65
- 4pcs 3030 LED (with lenses)
- 3 installations: Ceiling-mounted/ Wall-mounted/Recessed installation

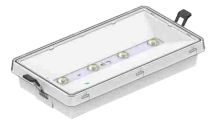
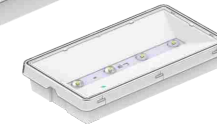
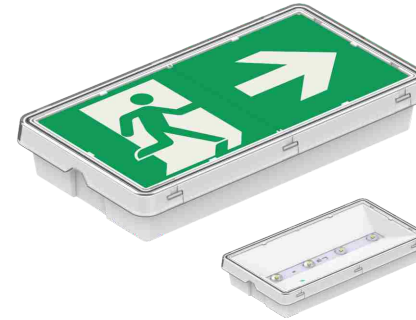

Model	Input Voltage	Battery	Charging / Fully charged	Luminous flux	Charge / Discharge	Size (mm)	Optional
DP-660LLi M	220-240VAC	3.2V 3.0Ah LiFePO4	3.0W / 3.5W	320/300lm (AC/DC)	24h / ≥3h	257x141x45	CBS & Self-test



DP-699LLi NM24

- Bulkhead, IP65
- 30pcs 5730 LEDs
- 1100lm (DC)
- Rotatable clear diffuser

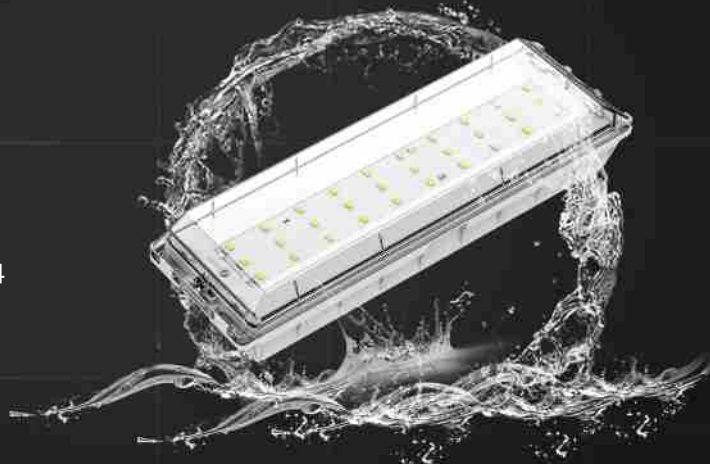

Model	Input Voltage	Battery	Charging / Fully charged	Luminous flux	Charge / Discharge	Size (mm)	Optional
DP-699LLi NM24	220-240VAC	6.4V 5.5Ah LiFePO4	3.5W / 0.5W	1100lm (DC)	24h / ≥3h	345x110x66	Self-test & DALI-2



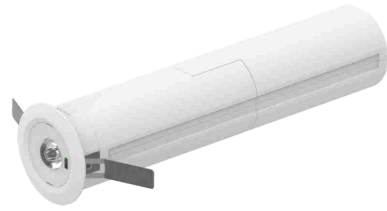

DP-5WLLiK NM-ZD

- 1pc SMD LED, 250lm (DC)
- Two lenses with different beam angles
- IP40

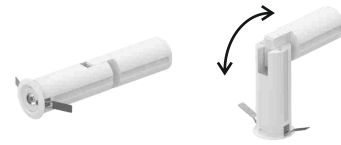

Model	Input Voltage	Battery	Charging / Fully charged	Luminous flux	Charge / Discharge	Size (mm)	Optional
DP-5WLLiK NM-ZD	220-240VAC	3.2V 3.0Ah LiFePO4	2.0W / 0.5W	250lm (DC)	24h / ≥3h	60x48x238	CBS & Self-test

DP-7WLLiK M-P24-2

- Replaceable lenses
- 3.2V 5.5Ah LiFePO4 battery

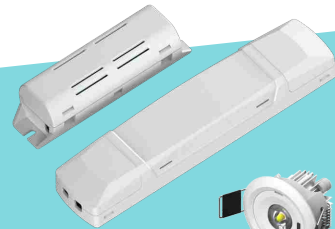

DP-5WLLiK M-P24-2

- High efficiency heat-sink part
- Recessed installation
- 3.2V 3.0Ah LiFePO4 battery

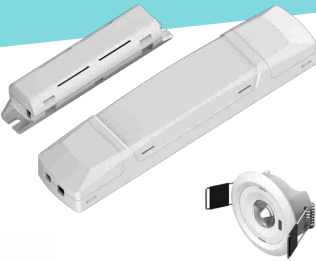

DP-2WLLiK M-P24-2

- High quality SMD LED
- LiFePO4 battery, long life time
- Two lenses with different beam angles



Model	Input Voltage	Battery	Charging / Fully charged	Luminous flux	Charge / Discharge	Size (mm)	Optional
DP-7WLLiK M-P24-2	220-240VAC	3.2V 5.5Ah LiFePO4	3.5W / 4.5W	360/300lm (AC/DC)	24h / ≥3h	180x40x24 (PCB) Φ55x64 (7W Lamp) Φ55x44 (5W Lamp) Φ55x29 (2W Lamp)	Self-test & DALI-2
DP-5WLLiK M-P24-2	220-240VAC	3.2V 3.0Ah LiFePO4	3.0W / 3.5W	270/250lm (AC/DC)	24h / ≥3h		CBS
DP-2WLLiK M-P24-2	220-240VAC	3.2V 1.5Ah LiFePO4	2.5W / 2.5W	130/120lm (AC/DC)	24h / ≥3h		Self-test & DALI-2

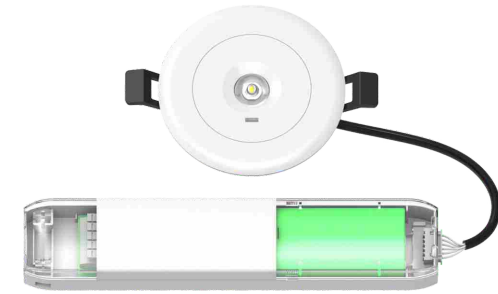

DP-5WLLiK NM26

- 1pc SMD LED, 400lm (DC)
- Two lenses with different beam angles
- Integrated housing for PCB and battery
- IP40



Model	Input Voltage	Battery	Charging / Fully charged	Luminous flux	Charge / Discharge	Size (mm)	Optional
DP-5WLLiK NM26	220-240VAC	6.4V 2.0Ah LiFePO4	2.0W / 0.5W	400lm (DC)	24h / ≥3h	210x42x26 (PCB) Φ95x30 (Lamp)	CBS & Self-test

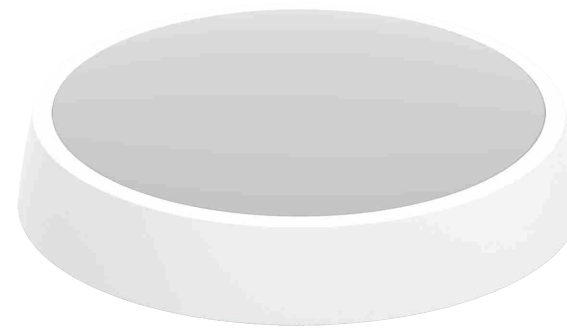

DP-6668LLi M

- 36pcs 3030 LEDs with wide lenses
- Commercial/Emergency Lighting
- IP65



Model	Input Voltage	Battery	Charging / Fully charged	Luminous flux	Charge / Discharge	Size (mm)	Optional
DP-6668LLi M	220-240VAC	3.2V 3.0Ah LiFePO4	15W / 14W	1000/220lm (AC/DC)	24h / ≥3h	Φ308x68	CBS & Self-test



DP-8016LLiK NM

- 1pc SMD LED, 250/230lm (K/X)
- Two lenses with different beam angles
- Ceiling-mounted/Wall-mounted installation
- IP65

Model	Input Voltage	Battery	Charging / Fully charged	Luminous flux	Charge / Discharge	Size (mm)	Optional
DP-8016LLiK NM	220-240VAC	3.2V 3.0Ah LiFePO4	2.5W / 0.5W	250lm (DC)	24h / ≥3h	160x160x43	Self-test



DP-8022LLiK NM

- 1pc SMD LED, 250/230lm (K/X)
- Two lenses with different beam angles
- Surface-mounted/Recessed installation
- IP40



Model	Input Voltage	Battery	Charging / Fully charged	Luminous flux	Charge / Discharge	Size (mm)	Optional
DP-8022LLiK NM	220-240VAC	3.2V 3.0Ah LiFePO4	2.0W / 0.5W	250lm (DC)	24h / ≥3h	Φ104x66	Self-test



DP-8066LLiK NM

- 1pc SMD LED, 260/250lm (K/X)
- Two lenses with different beam angles
- Surface-mounted/Recessed installation
- IP65



Model	Input Voltage	Battery	Charging / Fully charged	Luminous flux	Charge / Discharge	Size (mm)	Optional
DP-8066LLiK NM	220-240VAC	3.2V 3.0Ah LiFePO4	2.0W / 0.5W	260lm (DC)	24h / ≥3h	Φ155x46	Self-test & DALI-2

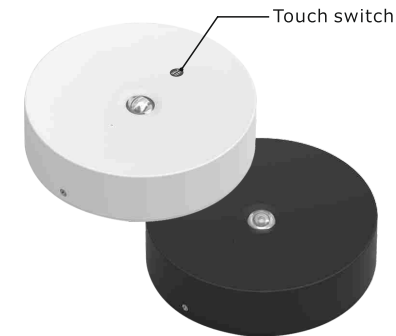

DP-8026LLiK NM

- 1pc SMD LED, 250/230lm (K/X)
- Two lenses with different beam angles
- Touch switch
- IP42



LLiK



LLiX



Model	Input Voltage	Battery	Charging / Fully charged	Luminous flux	Charge / Discharge	Size (mm)	Optional
DP-8026LLiK NM	220-240VAC	3.2V 3.0Ah LiFePO4	2.5W / 0.5W	250lm (DC)	24h / ≥3h	Φ150x39	Self-test



DP-8038LLiK NM

- 1pc SMD LED, 250/230lm (K/X)
- Two lenses with different beam angles
- Emergency Corridor/Ceiling Light
- IP65

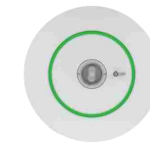

Model	Input Voltage	Battery	Charging / Fully charged	Luminous flux	Charge / Discharge	Size (mm)	Optional
DP-8038LLiK NM	220-240VAC	3.2V 3.0Ah LiFePO4	3.0W / 0.5W	250lm (DC)	24h / ≥3h	Φ188x42.5	Self-test

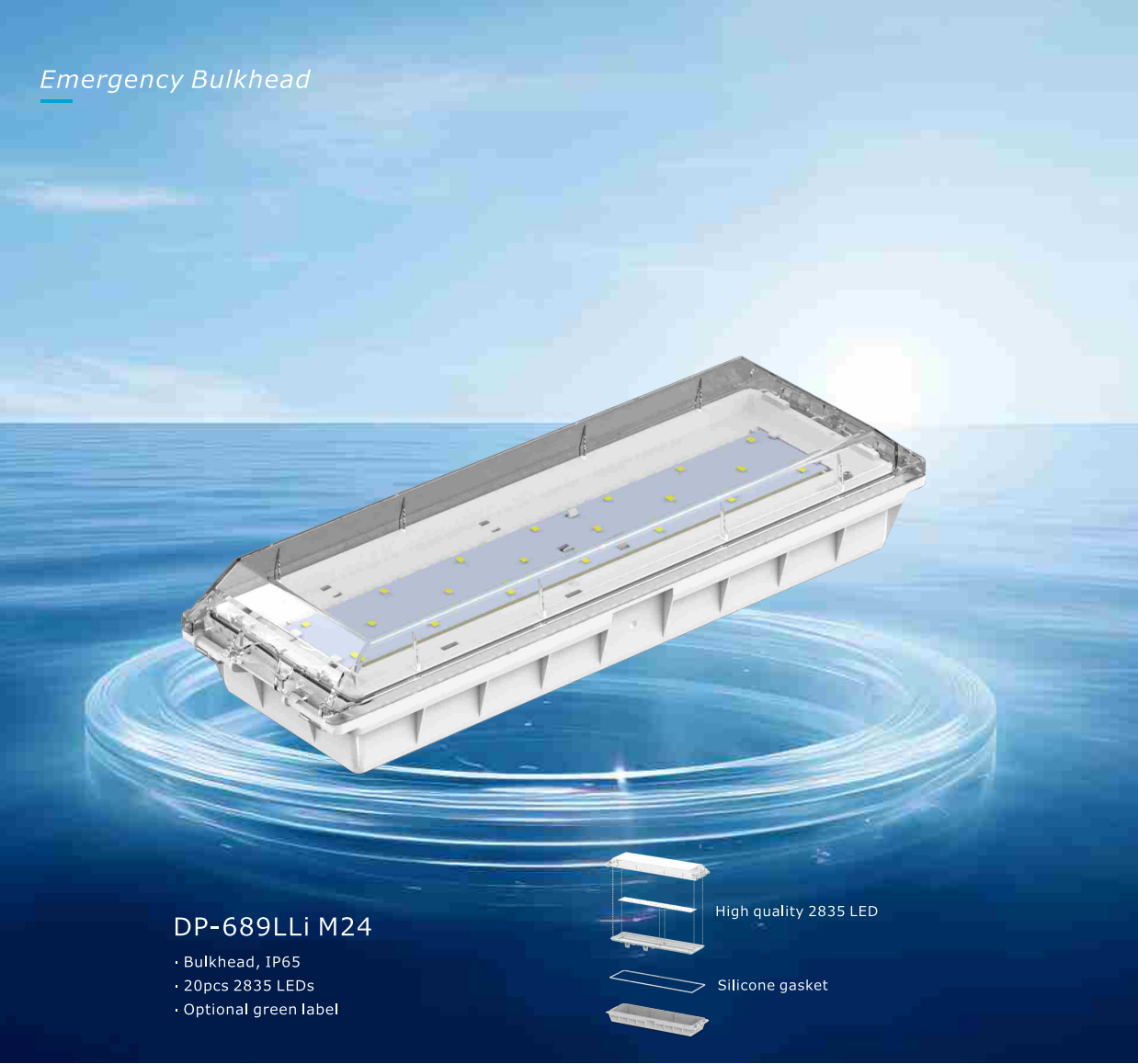

DP-689LLi M24

- Bulkhead, IP65
- 20pcs 2835 LEDs
- Optional green label



Model	Input Voltage	Battery	Charging / Fully charged	Luminous flux	Charge / Discharge	Size (mm)	Optional
DP-689LLi M24	220-240VAC	3.2V 1.5Ah LiFePO4	3.0W / 3.5W	350/200lm (AC/DC)	24h / ≥3h	345x110x66	CBS & Self-test



Rotatable gear tray design

DP-629LLi M24

- 20pcs 2835 LEDs
- PC housing
- Optional green label



DP-628LLi M24

- 8pcs 2835 LEDs
- 350/110lm (AC/DC)
- Optional green label



Model	Input Voltage	Battery	Charging / Fully charged	Luminous flux	Charge / Discharge	Size (mm)	Optional
DP-629LLi M24	220-240VAC	3.2V 1.5Ah LiFePO4	3.0W / 3.5W	350/200lm (AC/DC)	24h / ≥3h	349x107x64	CBS & Self-test
DP-628LLi M24	220-240VAC	3.2V 1.0Ah LiFePO4	3.5W / 3.0W	350/110lm (AC/DC)	24h / ≥3h	349x107x64	CBS & Self-test

DP-688LLi M24

- 8pcs 2835 LEDs
- 350/110lm (AC/DC)
- Rotatable clear diffuser

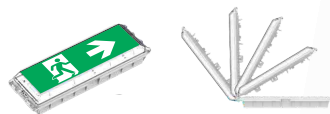

Model	Input Voltage	Battery	Charging / Fully charged	Luminous flux	Charge / Discharge	Size (mm)	Optional
DP-688LLi M24	220-240VAC	3.2V 1.0Ah LiFePO4	3.5W / 3.0W	350/110lm (AC/DC)	24h / ≥3h	345x110x66	CBS & Self-test

DP-641LLi M24

- Bulkhead, IP65
- 41pcs 2835 LEDs
- 350/200lm (AC/DC)



Model	Input Voltage	Battery	Charging / Fully charged	Luminous flux	Charge / Discharge	Size (mm)	Optional
DP-641LLi M24	220-240VAC	3.2V 1.5Ah LiFePO4	3.0W / 3.5W	350/200lm (AC/DC)	24h / ≥3h	352x110x64	Self-test & DALI-2



DP-618LLi M24

DP-630LLi M24

DP-608LLi M24

DP-638L M

Model	Input Voltage	Battery	Charging / Fully charged	Luminous flux	Charge / Discharge	Size (mm)	Optional
DP-608LLi M24	220-240VAC	3.2V 1.0Ah LiFePO4	2.0W / 2.5W	170/110lm (AC/DC)	24h / ≥3h	276x110x60	CBS & Self-test
DP-630LLi M24	220-240VAC	3.2V 1.0Ah LiFePO4	2.0W / 2.5W	170/110lm (AC/DC)	24h / ≥3h	352x118x75	CBS & Self-test
DP-618LLi M24	220-240VAC	3.2V 1.0Ah LiFePO4	2.0W / 2.5W	170/110lm (AC/DC)	24h / ≥3h	254x93x58	CBS & Self-test
DP-638L M	220-240VAC	3.6V 1.5Ah Ni-Cd	4.0W / 3.5W	215/170lm (AC/DC)	24h / ≥3h	352x110x64	Self-test

DP-638LBLi M24

- 8pcs 2835 LEDs
- 350/110lm (AC/DC)
- Optional green label



Model	Input Voltage	Battery	Charging / Fully charged	Luminous flux	Charge / Discharge	Size (mm)	Optional
DP-638LBLi M24	220-240VAC	3.2V 1.0Ah LiFePO4	3.5W / 3.5W	350/110lm (AC/DC)	24h / ≥3h	352x110x64	Self-test & DALI-2

DP-668LLi M24

- 20pcs 2835 LEDs
- Optional green label
- Ceiling-mounted/Wall-mounted installation



Model	Input Voltage	Battery	Charging / Fully charged	Luminous flux	Charge / Discharge	Size (mm)	Optional
DP-668LLi M24	220-240VAC	3.2V 1.5Ah LiFePO4	3.0W / 3.5W	350/200lm (AC/DC)	24h / ≥3h	347x107x76	CBS & Self-test

DP-680LLi M24

- 8pcs 2835 LEDs
- Clear diffuser and base fixed by clips
- Optional green label



Model	Input Voltage	Battery	Charging / Fully charged	Luminous flux	Charge / Discharge	Size (mm)	Optional
DP-680LLi M24	220-240VAC	3.2V 1.0Ah LiFePO4	2.0W / 2.5W	170/110lm (AC/DC)	24h / ≥3h	351x95x74	CBS & Self-test



DP-998LLi M24

- LiFePO4 battery, long life time
- For outdoor use, IP65



Foamed silicone



Silicone gasket

Model	Input Voltage	Battery	Charging / Fully charged	Visible Distance	Charge / Discharge	Size (mm)	Optional
DP-998LLi M24	220-240VAC	3.2V 1.0Ah LiFePO4	2.0W / 2.5W	24m	24h / ≥3h	315x45x221	CBS & Self-test



DP-955LLi M24

- Uniform surface illumination
- Acrylic plate rotated 180°
- LiFePO4 battery, long life time



Model	Input Voltage	Battery	Charging / Fully charged	Visible Distance	Charge / Discharge	Size (mm)	Optional
DP-955LLi M24	220-240VAC	3.2V 1.0Ah LiFePO4	2.0W / 2.5W	24m	24h / ≥3h	315x40x219	CBS & Self-test



DP-966LLi M24

- Luminous transparent edges
- PC housing and acrylic plate
- LiFePO4 battery, long life time



Model	Input Voltage	Battery	Charging / Fully charged	Visible Distance	Charge / Discharge	Size (mm)	Optional
DP-966LLi M24	220-240VAC	3.2V 1.0Ah LiFePO4	2.0W / 2.5W	24m	24h / ≥3h	320x68x209	CBS & Self-test



DP-908LLi M

- High-end exit sign with aluminum housing
- LiFePO4 battery, long life time



Model	Input Voltage	Battery	Charging / Fully charged	Visible Distance	Charge / Discharge	Size (mm)	Optional
DP-908LLi M	220-240VAC	3.2V 1.0Ah LiFePO4	4.0W / 2.5W	24m	24h / ≥3h	310x30x212	CBS & Self-test

DP-999LLi M24

- Acrylic plate rotated 180°
- LiFePO4 battery, long life time
- 5 installations



Model	Input Voltage	Battery	Charging / Fully charged	Visible Distance	Charge / Discharge	Size (mm)	Optional
DP-999LLi M24	220-240VAC	3.2V 1.0Ah LiFePO4	2.0W / 2.5W	24m	24h / ≥3h	344x42x237	Self-test & DALI-2



DP-938LLi M24

- Uniform surface illumination
- Adjustable height light-emitting panel
- LiFePO4 battery, long life time



Model	Input Voltage	Battery	Charging / Fully charged	Visible Distance	Charge / Discharge	Size (mm)	Optional
DP-938LLi M24	220-240VAC	3.2V 1.0Ah LiFePO4	2.0W / 2.5W	24m	24h / ≥3h	340x45x214	CBS & Self-test

DP-939LLi M24

- PC housing and acrylic plate
- Interchangeable PC/PVC legend
- 4 installations



Model	Input Voltage	Battery	Charging / Fully charged	Visible Distance	Charge / Discharge	Size (mm)	Optional
DP-939LLi M24	220-240VAC	3.2V 1.0Ah LiFePO4	2.0W / 2.5W	24m	24h / ≥3h	350x40x240	CBS & Self-test



DP-991LLi M24

- Uniform surface illumination
- Manual test switch
- 5 installations



Model	Input Voltage	Battery	Charging / Fully charged	Visible Distance	Charge / Discharge	Size (mm)	Optional
DP-991LLi M24	220-240VAC	3.2V 1.0Ah LiFePO4	2.0W / 2.5W	18m	24h / ≥3h	264x28x211	CBS & Self-test

DP-933LLi M24

- Uniform surface illumination
- Manual test switch
- 5 installations



Model	Input Voltage	Battery	Charging / Fully charged	Visible Distance	Charge / Discharge	Size (mm)	Optional
DP-933LLi M24	220-240VAC	3.2V 1.0Ah LiFePO4	2.0W / 2.5W	18m	24h / ≥3h	264x28x181.3	CBS & Self-test

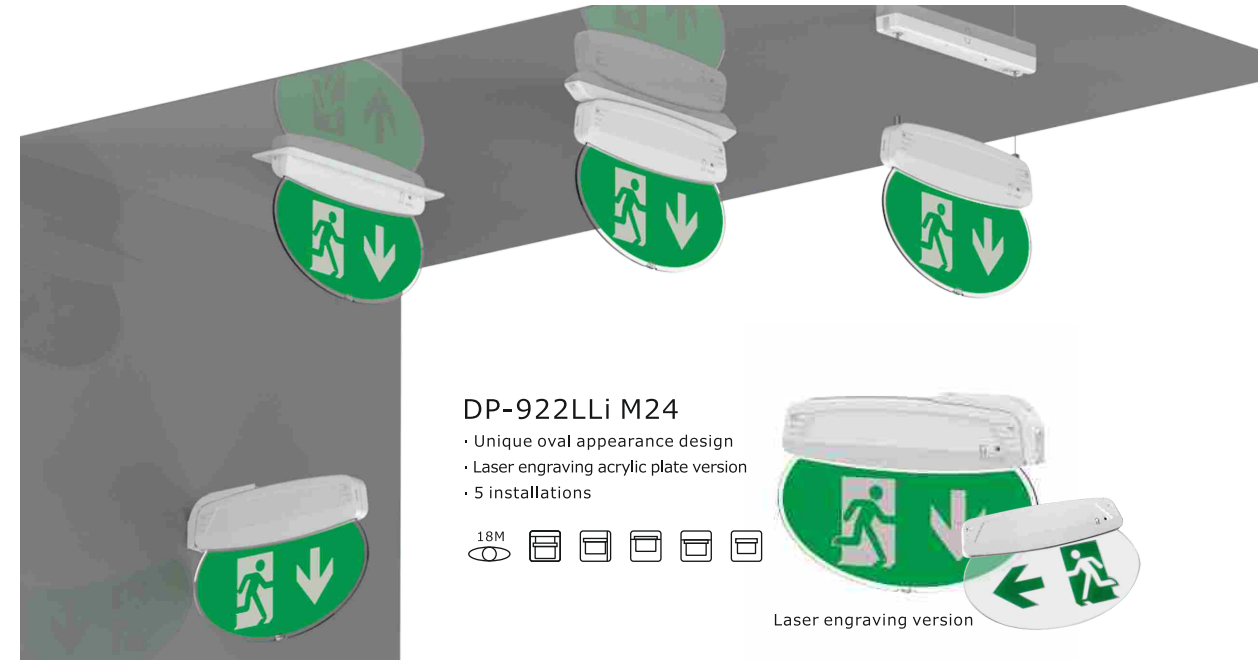

DP-922LLi M24

- Unique oval appearance design
- Laser engraving acrylic plate version
- 5 installations



Laser engraving version

Model	Input Voltage	Battery	Charging / Fully charged	Visible Distance	Charge / Discharge	Size (mm)	Optional
DP-922LLi M24	220-240VAC	3.2V 1.0Ah LiFePO4	2.0W / 2.5W	18m	24h / ≥3h	290x28x201	CBS & Self-test

Emergency Exit Sign



DP-630LLiEXIT M24

- LiFePO4 battery, long life time
- Maintained/Non-maintained
- Acrylic light guide plate for even light distribution



Model	Input Voltage	Battery	Charging / Fully charged	Visible Distance	Charge / Discharge	Size (mm)	Optional
DP-630LLiEXIT M24	220-240VAC	3.2V 1.0Ah LiFePO4	2.0W / 2.5W	24m	24h / ≥3h	352x118x243	CBS & Self-test



DP-989L M

- 12pcs Φ5 LEDs, Maintained
- Frosted painted metal housing
- 3 installations



Model	Input Voltage	Battery	Charging / Fully charged	Visible Distance	Charge / Discharge	Size (mm)
DP-989L M	220-240VAC	3.6V 0.8Ah Ni-Cd	4.5W / 4.0W	24m	24h / ≥3h	353x34x254



(DP-9811LLi Back)

DP-9811LLi M (Single-sided) DP-9822LLi M (Double-sided)

- 14pcs Φ5 LEDs
- Ceiling suspended installation
- PC housing and PVC panel



(DP-9822LLi Back)

Model	Input Voltage	Battery	Charging / Fully charged	Visible Distance	Charge / Discharge	Size (mm)	Optional
DP-9811LLi M	220-240VAC	3.2V 0.5Ah LiFePO4	2.0W / 2.0W	24m	24h / ≥3h	330x155x26	Self-test
DP-9822LLi M	220-240VAC	3.2V 0.5Ah LiFePO4	2.0W / 2.0W	24m	24h / ≥3h	330x155x26	Self-test





Downlight

DP-3229LLi M24

- Replace the legend quickly
- Exit box with downlight
- Periodic self-test function

24M

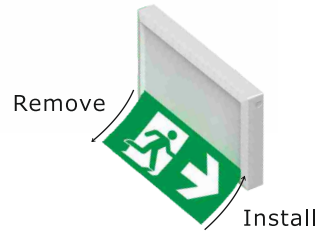

Remove

Install

Model	Input Voltage	Battery	Charging / Fully charged	Visible Distance	Charge / Discharge	Size (mm)	Optional
DP-3229LLi M24	220-240VAC	3.2V 1.0Ah LiFePO4	1.5W / 2.0W	24m	24h / ≥3h	330x185x39	Self-test & DALI-2



DP-3228LLi M24

- 20pcs 3014 LEDs/5pcs 2835 LEDs as the downlight
- Cover and base fixed by clips
- Manual test switch

24M



Downlight

Model	Input Voltage	Battery	Charging / Fully charged	Visible Distance	Charge / Discharge	Size (mm)	Optional
DP-3228LLi M24	220-240VAC	3.2V 1.0Ah LiFePO4	1.5W / 2.0W	24m	24h / ≥3h	320x185x26	CBS & Self-test



DP-3218L M

- Ultra-thin emergency exit box, up to 26mm
- 20pcs 3014 LEDs/6pcs Φ5 LEDs as the downlight
- Viewing distance up to 32m

32M



Model	Input Voltage	Battery	Charging / Fully charged	Visible Distance	Charge / Discharge	Size (mm)	Optional
DP-3218L M	220-240VAC	3.6V 2.0Ah Ni-MH	4.0W / 3.5W	32m	24h / ≥3h	394x195x26	Self-test



DP-3288LLi M

- Replace the legend quickly
- White/Black version

32M



Model	Input Voltage	Battery	Charging / Fully charged	Visible Distance	Charge / Discharge	Size (mm)	Optional
DP-3288LLi M	220-240VAC	3.2V 1.5Ah LiFePO4	3.5W / 2.0W	32m	24h / ≥3h	350x80x219	CBS & Self-test



DP-338LLi M24
 · Maintained/Non-maintained
 · PC panel with silk screen pattern
 32M

Model	Input Voltage	Battery	Charging / Fully charged	Visible Distance	Charge / Discharge	Size (mm)	Optional
DP-338LLi M24	220-240VAC	3.2V 1.0Ah LiFePO4	2.0W / 2.5W	32m	24h / ≥3h	390x60x190	CBS & Self-test

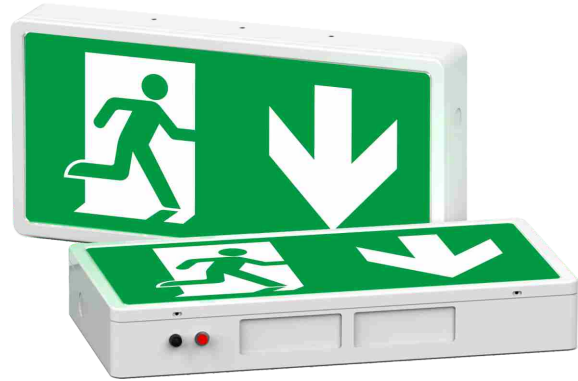

DP-318LLi M24
 · Manual test switch
 · Metal housing, PC panel
 · Attractive and durable
 32M

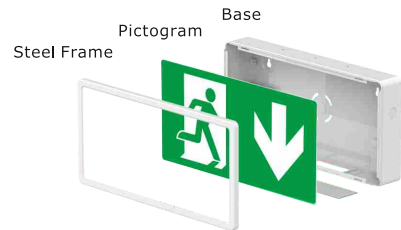

Model	Input Voltage	Battery	Charging / Fully charged	Visible Distance	Charge / Discharge	Size (mm)	Optional
DP-318LLi M24	220-240VAC	3.2V 1.0Ah LiFePO4	2.0W / 2.5W	32m	24h / ≥3h	390x60x190	CBS & Self-test



DP-630LLi MT24
 · Passed high voltage test (1500V)
 · Ceiling-mounted/Recessed installation



Model	Input Voltage	Battery	Charging / Fully charged	Visible Distance	Charge / Discharge	Size (mm)	Optional
DP-630LLi MT24	220-240VAC	3.2V 1.0Ah LiFePO4	2.0W / 2.5W	32m	24h / ≥3h	352x118x199	CBS & Self-test

DP-638LBLi MT24

- Passed high voltage test (1500V)
 - Flame-retardant PC material
- 32M



Model	Input Voltage	Battery	Charging / Fully charged	Visible Distance	Charge / Discharge	Size (mm)	Optional
DP-638LBLi MT24	220-240VAC	3.2V 1.0Ah LiFePO4	3.5W / 3.5W	32m	24h / ≥3h	352x110x224	Self-test & DALI-2



DP-680LLi MT24
 · PVC green label
 · Maintained/Non-maintained

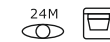

Model	Input Voltage	Battery	Charging / Fully charged	Visible Distance	Charge / Discharge	Size (mm)	Optional
DP-680LLi MT24	220-240VAC	3.2V 1.0Ah LiFePO4	2.0W / 2.5W	24m	24h / ≥3h	351x95x190	CBS & Self-test



DP/NM3/108L/Li/65/24

- Individual adjustable lamp head
- Multiple cable entry holes for loop-in & loop-out
- For outdoor use, IP65

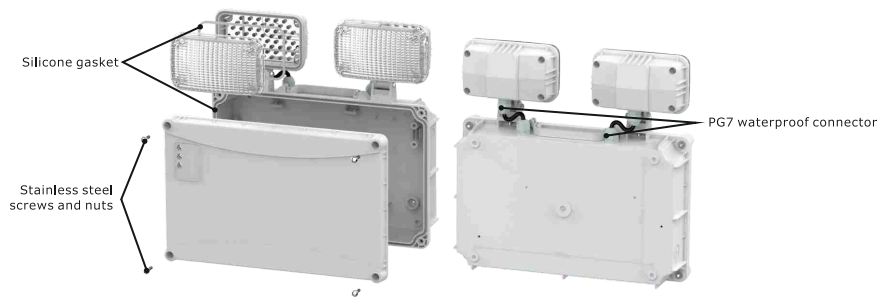

Model	Input Voltage	Battery	Charging / Fully charged	Luminous flux	Charge / Discharge	Size (mm)	Optional
DP/NM3/108L/Li/65/24	220-240VAC	3.2V 5.5Ah LiFePO4	3.0W / 0.5W	520lm (DC)	24h / ≥3h	300x70x294	Self-test DALI-2

DP/NM3/80L/Li/24

- Lamp head rotated and adjusted independently
- 80pcs Φ5 LEDs
- IP20



Model	Input Voltage	Battery	Charging / Fully charged	Luminous flux	Charge / Discharge	Size (mm)	Optional
DP/NM3/80L/Li/24	220-240VAC	3.2V 3.0Ah LiFePO4	2.5W / 0.5W	360lm (DC)	24h / ≥3h	280x55.5x308.5	Self-test



DP/NM3/80L/Li/65/24

- 80pcs Φ5 LEDs
- PC housing
- IP65



Model	Input Voltage	Battery	Charging / Fully charged	Luminous flux	Charge / Discharge	Size (mm)	Optional
DP/NM3/80L/Li/65/24	220-240VAC	3.2V 3.0Ah LiFePO4	2.5W / 0.5W	400lm (DC)	24h / ≥3h	297x70x282	Self-test

DP/NM3/60L/Li/65/24

- Ceiling-mounted/Wall-mounted installation
- PC housing
- IP65

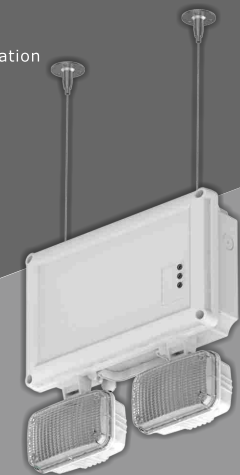

Model	Input Voltage	Battery	Charging / Fully charged	Luminous flux	Charge / Discharge	Size (mm)	Optional
DP/NM3/60L/Li/65/24	220-240VAC	3.2V 3.0Ah LiFePO4	2.5W / 0.5W	380lm (DC)	24h / ≥3h	292x70.5x279	Self-test

Emergency Ceiling Light

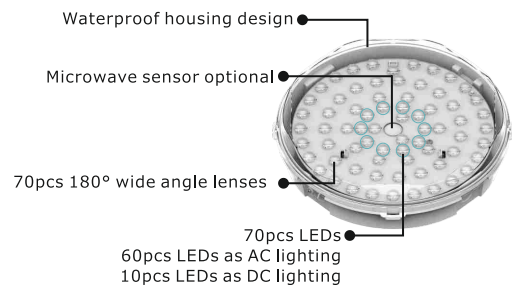

DP-6688LLi M

- 70pcs 3030 LEDs with wide lenses, 1650lm (AC)
- Commercial/Emergency Lighting
- CE, CB, UKCA certification



AC Mode

DC Mode

Model	Input Voltage	Battery	Charging / Fully charged	Luminous flux	Charge / Discharge	Size (mm)	Optional
DP-6688LLi M	220-240VAC	3.2V 2.0Ah LiFePO4	18W / 16W	1650/180lm (AC/DC)	24h / ≥3h	Φ304x80	CBS & Self-test



DP-6288LLi M

- 40pcs 5730 LEDs
- With microwave sensor, more energy-efficient
- IP65



Model	Input Voltage	Battery	Charging / Fully charged	Luminous flux	Charge / Discharge	Size (mm)	Optional
DP-6288LLi M	220-240VAC	3.2V 3.0Ah LiFePO4	14.5W / 12.5W	1175/180lm (AC/DC)	24h / ≥3h	Φ343x106	Self-test & Microwave

Emergency Ceiling & Corridor Light



DP-3266LLi M

- 54pcs 2835 LEDs, 805/430lm (100/50%)
- Split design for easy installation and maintenance
- Ceiling Light/Emergency Exit Sign

Model	Input Voltage	Battery	Charging / Fully charged	Luminous flux	Charge / Discharge	Size (mm)	Optional
DP-3266LLi M	220-240VAC	6.4V 1.5Ah LiFePO4	11W / 9.5W	805/180lm (AC/DC)	24h / ≥3h	Φ250x48	CBS & Self-test



DP-6WLLi M

- 2pcs SMD LEDs
- Commercial/Emergency Lighting
- Recessed/Surface-mounted installation



Model	Input Voltage	Battery	Charging / Fully charged	Luminous flux	Charge / Discharge	Size (mm)	Optional
DP-6WLLi M	220-240VAC	3.2V 5.5Ah LiFePO4	7.0W / 4.0W	315/360lm (AC/DC)	24h / ≥3h	210x107x54	CBS & Self-test

DP-8011LLi NM24

- Modular design, 4 lenses
- Non-maintained
- Corridor/Ceiling Light



Model	Input Voltage	Battery	Charging / Fully charged	Luminous flux	Charge / Discharge	Size (mm)	Optional
DP-8011LLi NM24	220-240VAC	3.2V 3.0Ah LiFePO4	2.5W / 0.5W	230lm (DC)	24h / ≥3h	130x130x45	Self-test

DP-8012LLi NM24

- Manual test switch
- High power & high efficiency LED



Model	Input Voltage	Battery	Charging / Fully charged	Luminous flux	Charge / Discharge	Size (mm)	Optional
DP-8012LLi NM24	220-240VAC	3.2V 3.0Ah LiFePO4	2.5W / 0.5W	230lm (DC)	24h / ≥3h	Φ150x44	Self-test

DP-8033LLi NM24

- High power & high efficiency LED
- IP65



LLIX



LLIC



NML

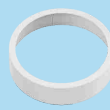

Model	Input Voltage	Battery	Charging / Fully charged	Luminous flux	Charge / Discharge	Size (mm)	Optional
DP-8033LLi NM24	220-240VAC	3.2V 3.0Ah LiFePO4	2.5W / 0.5W	270lm (DC)	24h / ≥3h	Φ170x70	Self-test
DP-8033L NML	220-240VAC	3.7V 2.6Ah Lithium	3.5W / 1.0W	155lm (DC)	24h / ≥3h	Φ170x70	Self-test

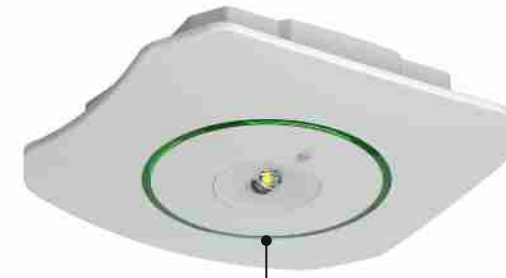

Round acrylic indicator (green)

DP-8028LLi NM24

- UFO industrial design
- Round acrylic indicator (green)
- Manual test switch



Model	Input Voltage	Battery	Charging / Fully charged	Luminous flux	Charge / Discharge	Size (mm)	Optional
DP-8028LLi NM24	220-240VAC	3.2V 3.0Ah LiFePO4	3.0W / 0.5W	200lm (DC)	24h / ≥3h	198x197x48	Self-test



DP-8013LLi C/X NM24

- Corridor/Ceiling Light
- Two lenses with different beam angles

Model	Input Voltage	Battery	Charging / Fully charged	Luminous flux	Charge / Discharge	Size (mm)	Optional
DP-8013LLi NM24	220-240VAC	3.2V 3.0Ah LiFePO4	3.0W / 0.5W	220lm (DC)	24h / ≥3h	180x110x49 (LLIC) 180x110x46 (LLIX)	Self-test

DP-7WLLi M24

- Replaceable lenses
- 3.2V 5.5Ah LiFePO4 battery



DP-5WLLi M24

- High efficiency heat-sink part
- Recessed installation
- 3.2V 3.0Ah LiFePO4 battery



DP-2WLLi M24

- High quality SMD LED
- LiFePO4 battery, long life time
- Manual test switch



Model	Input Voltage	Battery	Charging / Fully charged	Luminous flux	Charge / Discharge	Size (mm)	Optional
DP-7WLLi M24	220-240VAC	3.2V 5.5Ah LiFePO4	3.5W / 4.5W	320/300lm (AC/DC)	24h / ≥3h	150x42x26.5 (PCB)	CBS & Self-test
DP-5WLLi M24	220-240VAC	3.2V 3.0Ah LiFePO4	3.0W / 4.0W	260/230lm (AC/DC)	24h / ≥3h	Ø70x58 (7W Lamp) Ø70x48 (5W Lamp) Ø70x33 (2W Lamp)	CBS & Self-test
DP-2WLLi M24	220-240VAC	3.2V 1.5Ah LiFePO4	2.5W / 3.0W	135/110lm (AC/DC)	24h / ≥3h		CBS & Self-test



DP-8120LLi M

- 2100lm output (AC)
- 20W COB chip
- PCB and battery housing assembled and folded

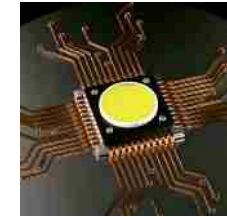

Model	Input Voltage	Battery	Charging / Fully charged	Luminous flux	Charge / Discharge	Size (mm)	Optional
DP-8120LLi M	220-240VAC	6.4V 3.0Ah LiFePO4	25W / 20W	2100/550lm (AC/DC)	24h / ≥3h	178x64x67 (PCB & Battery) Ø140x89 (Lamp)	CBS & Self-test

DP-8023LLi NM24

- Replaceable lenses
- Cylindrical heat-sink housing
- Manual test switch



Model	Input Voltage	Battery	Charging / Fully charged	Luminous flux	Charge / Discharge	Size (mm)	Optional
DP-8023LLi NM24	220-240VAC	3.2V 3.0Ah LiFePO4	1.5W / 0.5W	250lm (DC)	24h / ≥3h	Ø110x113	Self-test



DP-7WLLi M-P24

- Replaceable lenses
- 3.2V 5.5Ah LiFePO4 battery

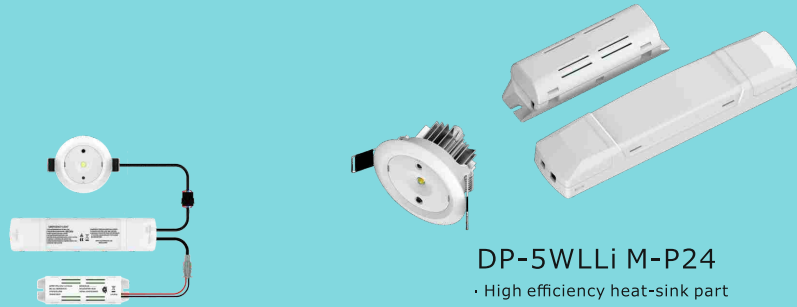
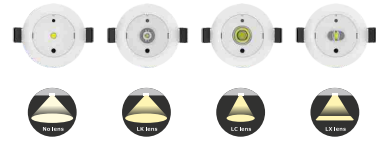

DP-5WLLi M-P24

- High efficiency heat-sink part
- Recessed installation
- 3.2V 3.0Ah LiFePO4 battery



DP-2WLLi NM-P24

- High quality SMD LED
- LiFePO4 battery, long life time
- Manual test switch



Model	Input Voltage	Battery	Charging / Fully charged	Luminous flux	Charge / Discharge	Size (mm)	Optional
DP-7WLLi M-P24	220-240VAC	3.2V 5.5Ah LiFePO4	3.5W / 4.5W	350/300lm (AC/DC)	24h / ≥3h	180x40x24 (PCB) ø70x59 (7W Lamp) ø70x49 (5W Lamp) ø50x39 (2W Lamp)	CBS & Self-test
DP-5WLLi M-P24	220-240VAC	3.2V 3.0Ah LiFePO4	3.0W / 3.5W	260/230lm (AC/DC)	24h / ≥3h		CBS & Self-test
DP-2WLLi NM-P24	220-240VAC	3.2V 1.5Ah LiFePO4	1.5W / 0.5W	125lm (DC)	24h / ≥3h		CBS & Self-test

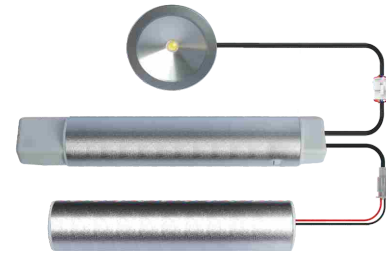

DP-1WL NM

- High-end downlight with aluminum housing
- High quality LED
- IP40

Model	Input Voltage	Battery	Charging / Fully charged	Luminous flux	Charge / Discharge	Size (mm)	Optional
DP-1WL NM	220-240VAC	3.6V 1.5Ah Ni-Cd	1.5W / 1.5W	125lm (DC)	24h / ≥3h	ø31x192 (PCB) ø45x33 (Lamp)	Self-test

DP-3WL M

- High-end downlight with aluminum housing
- High quality LED
- IP40

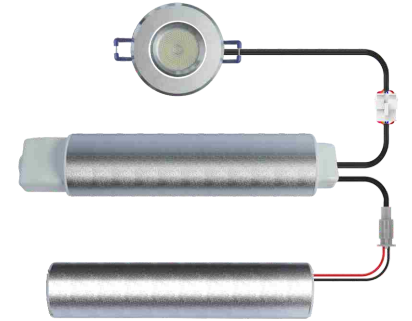

Model	Input Voltage	Battery	Charging / Fully charged	Luminous flux	Charge / Discharge	Size (mm)	Optional
DP-3WL M	220-240VAC	3.6V 3.0Ah Ni-Cd	5.0W / 6.5W	165/160lm (AC/DC)	24h / ≥3h	ø41x234 (PCB) ø70x31 (Lamp)	Self-test

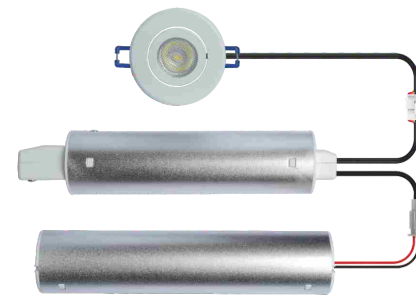

DP-5WL M

- Maintained/Non-maintained
- Metallic/White/Black
- Adjustable lamp cup's angle

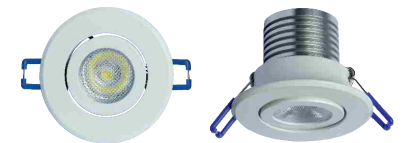

Model	Input Voltage	Battery	Charging / Fully charged	Luminous flux	Charge / Discharge	Size (mm)	Optional
DP-5WL M	220-240VAC	3.6V 4.5Ah Ni-Cd	7.0W / 8.5W	275/300lm (AC/DC)	24h / ≥3h	ø41x234 (PCB) ø78x52 (Lamp)	Self-test

DP-2WL M

- High-end downlight with aluminum housing
- High quality LED



Model	Input Voltage	Battery	Charging / Fully charged	Luminous flux	Charge / Discharge	Size (mm)	Optional
DP-2WL M	220-240VAC	3.6V 3.0Ah Ni-Cd	5.0W / 6.0W	230/230lm (AC/DC)	24h / ≥3h	Φ41x234 (PCB) Φ140x53 (Lamp)	CBS & Self-test

DP-8003LLi M

- Flame-retardant PC plastic housing
- Manual test switch
- Recessed installation

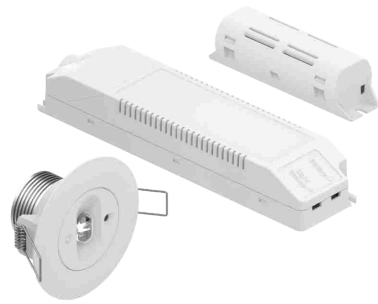

Model	Input Voltage	Battery	Charging / Fully charged	Luminous flux	Charge / Discharge	Size (mm)	Optional
DP-8003LLi M	220-240VAC	3.2V 3.0Ah LiFePO4	6.0W / 4.5W	315/230lm (AC/DC)	24h / ≥3h	210x50x32.4 (PCB) Φ85x41.5 (Lamp)	CBS & Self-test

DP-8005L M

- 3 replaceable lenses
- Large heat-sink part
- High quality NI-CD batteries

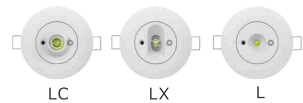
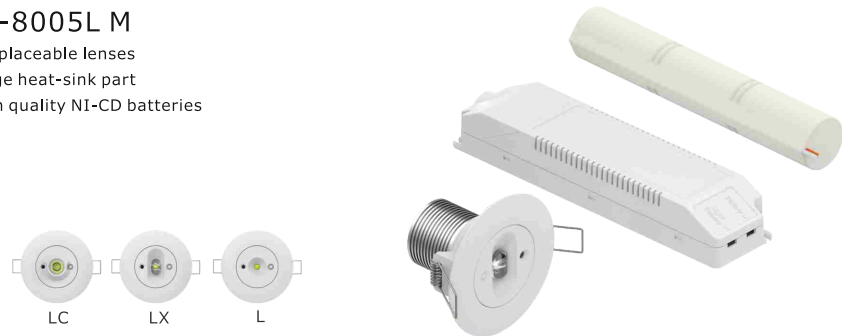

Model	Input Voltage	Battery	Charging / Fully charged	Luminous flux	Charge / Discharge	Size (mm)	Optional
DP-8005L M	220-240VAC	3.6V 4.5Ah Ni-Cd	6.5W / 7.5W	330/340lm (AC/DC)	24h / ≥3h	210x50x32.4 (PCB) Φ85x68 (Lamp)	CBS & Self-test

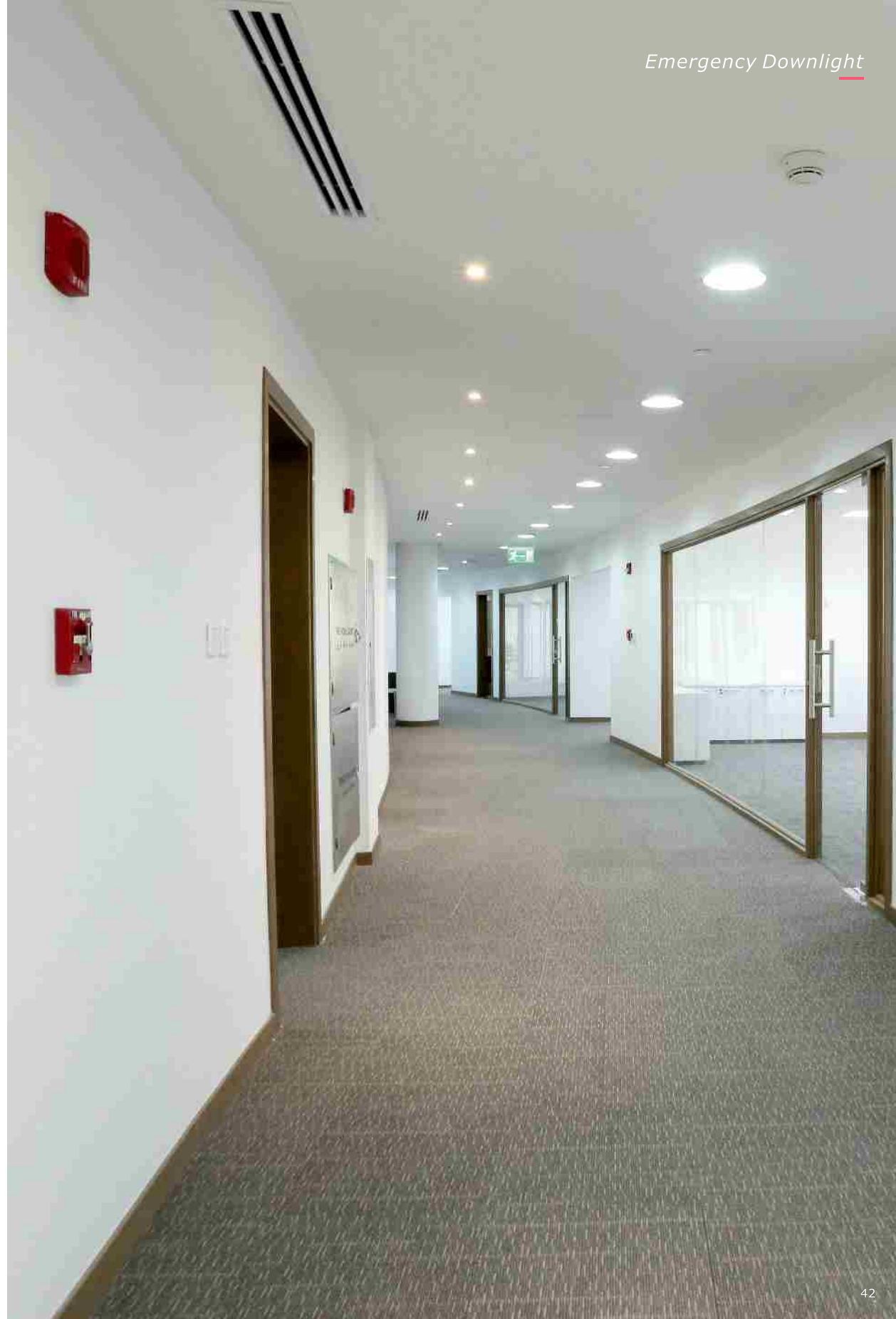

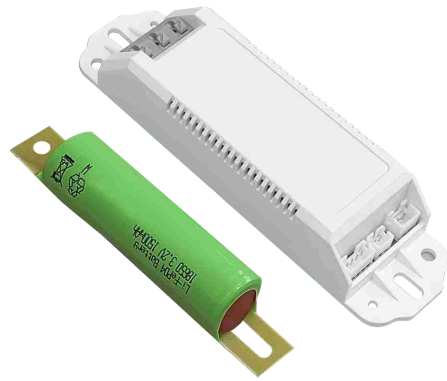

SAX8VLLiP(V2)

- LED output power : DC ≤ 1W
- Output voltage: 4-8V
- Output current: 160-200mA

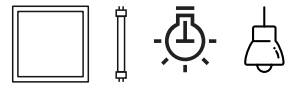

Model	Input Voltage	Battery	Charging / Fully charged	Charge / Discharge	Size (mm)	Optional
SAX8VLLiP(V2)	220-240VAC	3.2V 1.5Ah LiFePO4	1.5W / 0.5W	24h / ≥3h	130x33.5x23 (PCB) 100x19x19.5 (Battery)	Self-test



SAX5WLLi NM24

- Integrated housing for battery and PCB
- Gray cover as wire clip
- Output voltage: 10-60V
- Output current: 30mA

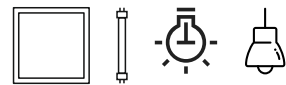

Model	Input Voltage	Battery	Charging / Fully charged	Charge / Discharge	Size (mm)	Optional
SAX5WLLi NM24	220-240VAC	6.4V 1.5Ah LiFePO4	3.0W / 0.5W	24h / ≥3h	220x52x28.5	Self-test

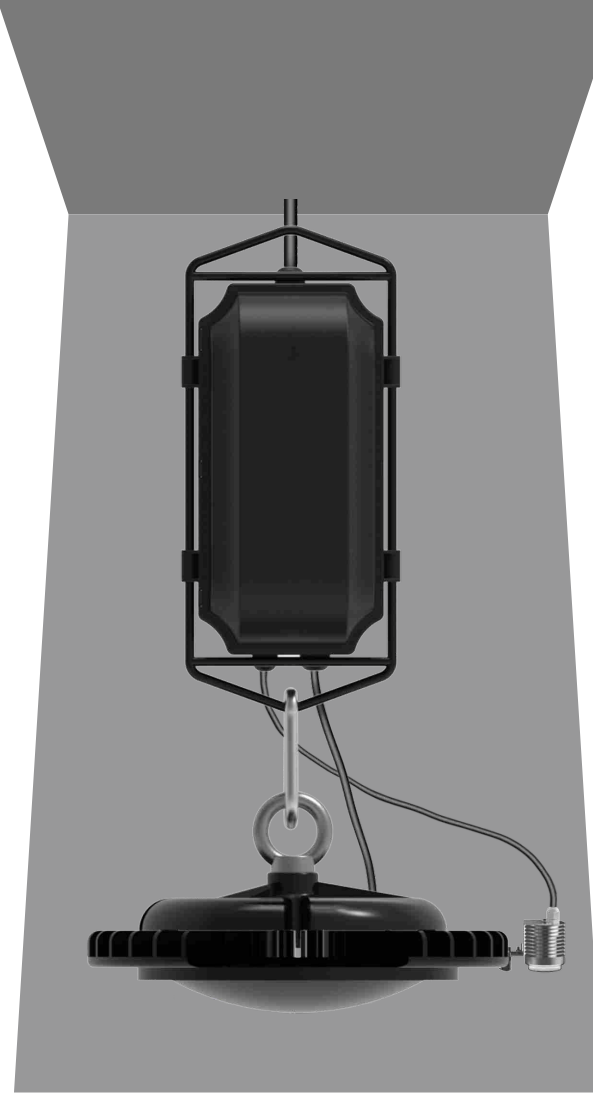

SAXGDPLLi 24

- With overdischarge and overcharge protection
- LED output power ≤ 5.5W
- IP65



Model	Input Voltage	Battery	Charging / Fully charged	Luminous flux	Charge / Discharge	Size (mm)	Optional
SAXGDPLLi 24	220-240VAC	6.4V 5.5Ah LiFePO4	3.5W / 0.5W	1000lm (DC)	24h / ≥3h	230x135.6x98 (PCB) Φ50x85 (Lamp)	Self-test & DALI-2

SAX60VLLi-2

- Adapt to load LED light source 10-60V
- Output current: 62mA



Model	Input Voltage	Battery	Charging / Fully charged	Charge / Discharge	Size (mm)	Optional
SAX60VLLi-2	220-240VAC	6.4V 3.0Ah LiFePO4	3.5W / 1.0W	24h / ≥3h	182x68x33	Self-test

Emergency Pack



SAX60VLLiPP-1

- Adapt to load LED light source 10-60V
- Output current: 80mA

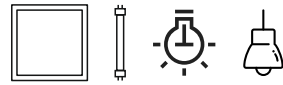

Model	Input Voltage	Battery	Charging / Fully charged	Charge / Discharge	Size (mm)	Optional
SAX60VLLiPP-1	220-240VAC	6.4V 3.0Ah LiFePO4	3.5W / 1.0W	24h / ≥3h	213x95x40	Self-test



SAX100VLLi-PP

- Adapt to load LED light source 10-100V
- Output current: 38mA
- IP20

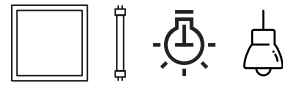

Model	Input Voltage	Battery	Charging / Fully charged	Charge / Discharge	Size (mm)	Optional
SAX100VLLi-PP	220-240VAC	6.4V 3.0Ah LiFePO4	4.0W / 0.5W	24h / ≥3h	210x68x32	Self-test & DALI-2

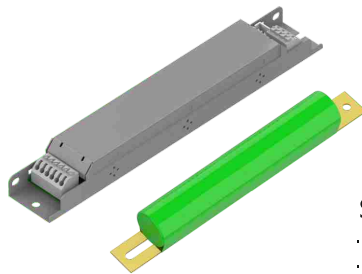

SAX100VLLi

- Adapt to load LED light source 10-100V
- Output current: 50mA
- Steel housing
- IP20

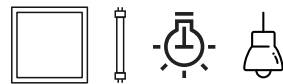

Model	Input Voltage	Battery	Charging / Fully charged	Charge / Discharge	Size (mm)	Optional
SAX100VLLi	220-240VAC	6.4V 4.0Ah LiFePO4	4.0W / 0.5W	24h / ≥3h	195x30x21 (PCB) 174x26.5x28 (Battery)	Self-test

SAX30VLP

- Adapt to load LED light source 10-30V

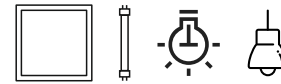

Model	Input Voltage	Battery	Charging / Fully charged	Charge / Discharge	Size (mm)	Optional
SAX30VLP	220-240VAC	4.8V 3.0Ah Ni-Cd	5.0W / 4.0W	24h / ≥3h	205x112x37	Self-test



SAX230VLLi

- Adapt to load LED light source 6-14W



Model	Input Voltage	Battery	Charging / Fully charged	Charge / Discharge	Size (mm)	Optional
SAX230VLLi	220-240VAC	12.8V 5.5Ah LiFePO4	5.0W / 1.5W	24h / ≥3h	290x38x28.6 (PCB) Φ32.5x288.5 (Battery)	Self-test

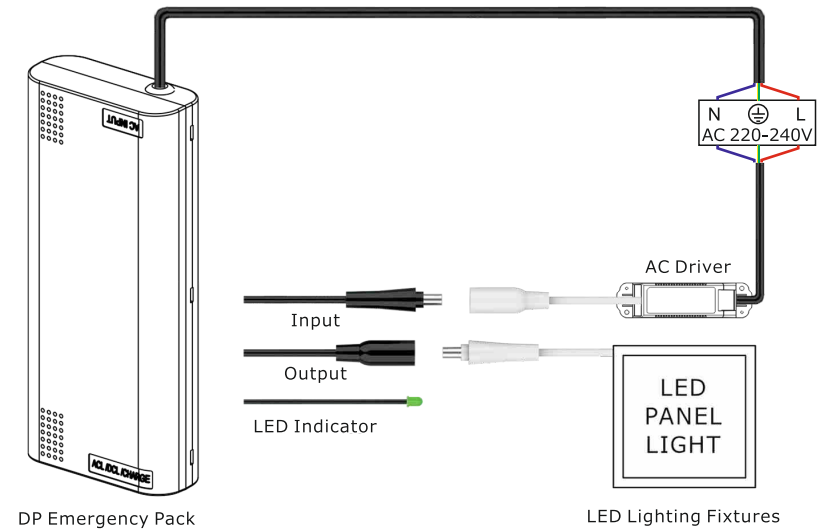

Wiring Diagram of DP Emergency Pack