

It harmonizes the sense of conflict between nature and humanity, creates extremely simple and humanized products with considerate functions, and permeates the caring and simple and plain art of life, so as to truly be "considerate and subtle".

协调了自然与人文的冲突感，创造出极致简约，功能体贴的人性化产品。渗透出关怀和简单、质朴的生活艺术，真正做到“体贴入微”。

BATHROOM AND KITCHEN
产品推广手册

艺术 · 品味 · 生活

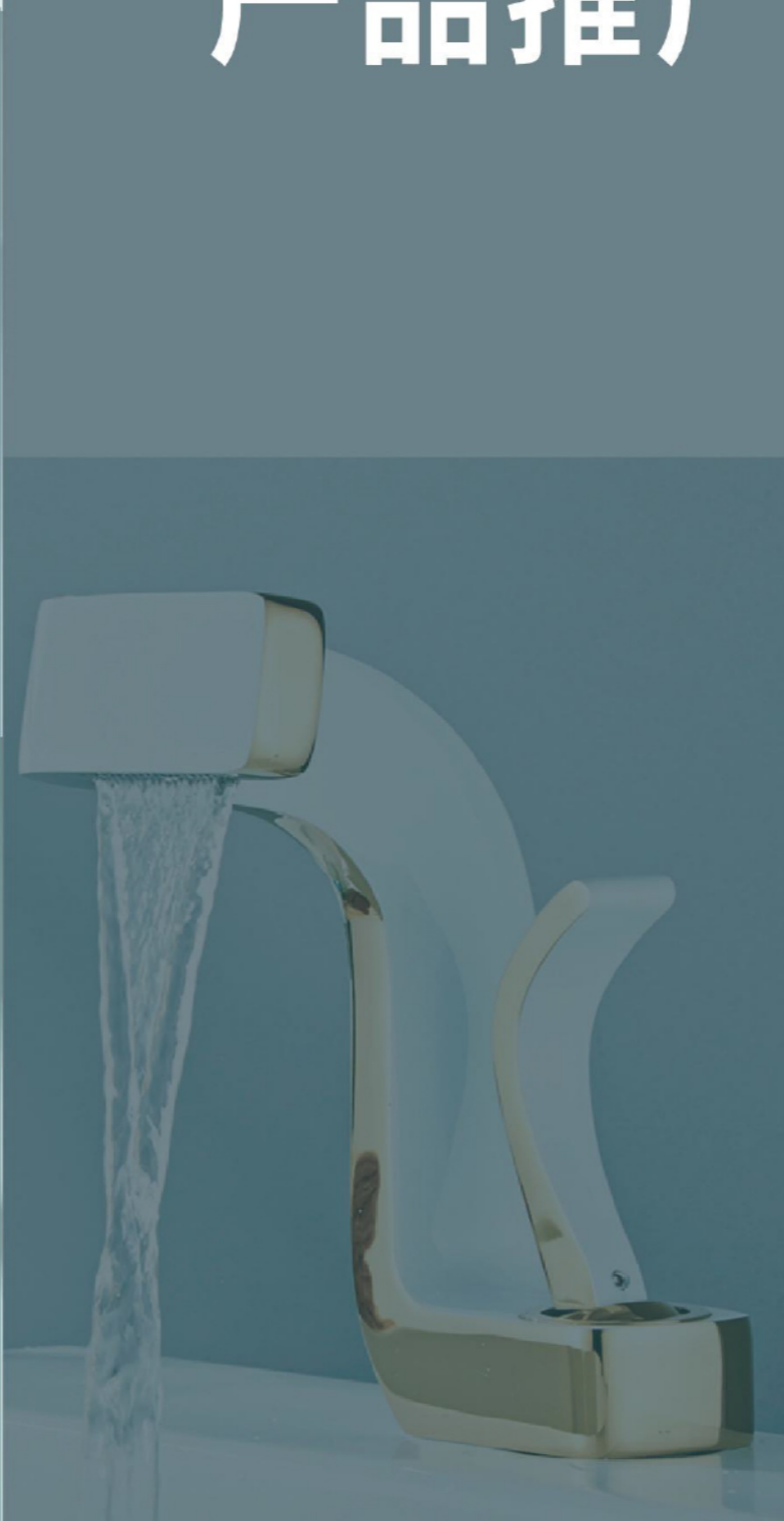

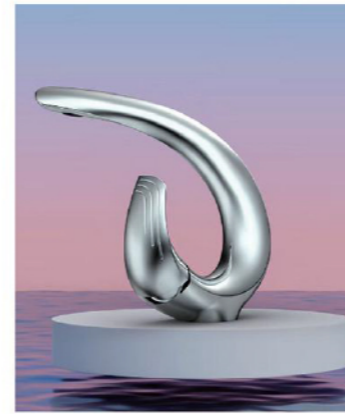

QL-001
电镀色 / CHROME



QL-002
黑色 / BLACK

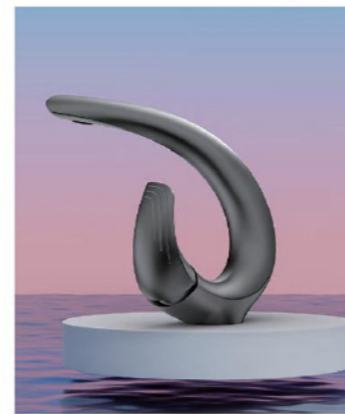

QL-003
枪灰色 / GUN GRAY



QL-004
白色 / WHITE

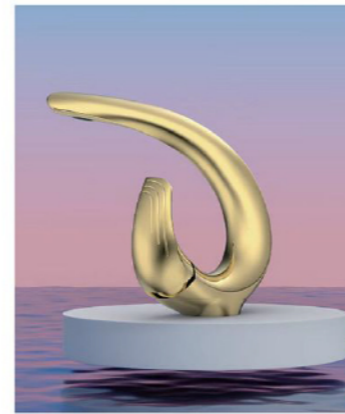

QL-005
金色 / GOLD

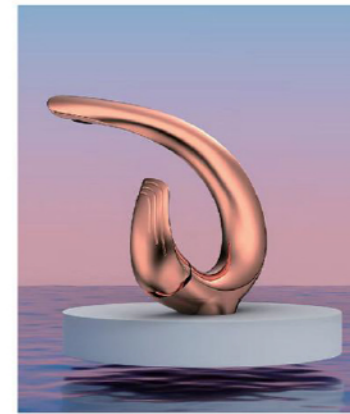

QL-006
玫瑰色 / ROSE GOLD



QL-008
镍拉丝 / NICKEL WIRE DRAWING

青龙系列 Qinglong Series

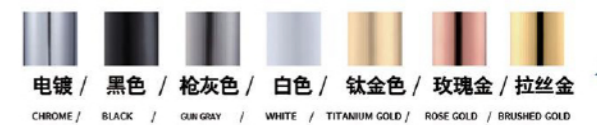



WJ- 001
电镀色 / CHROME



WJ- 002
黑色 / BLACK



WJ- 003
枪灰色 / GUN GRAY



WJ- 004
白色 / WHITE



WJ- 005
金色 / GOLD



WJ- 006
玫瑰色 / ROSE GOLD

面盆龙头系列
Basin faucet series



QZ- 001
电镀色 / CHROME



QZ- 002
黑色 / BLACK

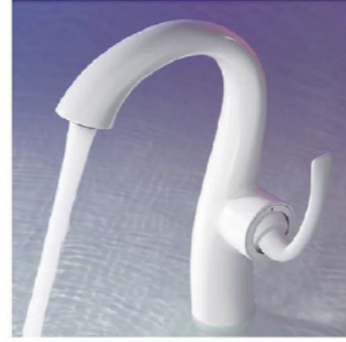

QZ- 004
白色 / WHITE



QZ- 005
金色 / GOLD



QZ- 006
玫瑰色 / ROSE GOLD

乔治系列 George series



面盆龙头系列
Basin faucet series



TZ- 001
电镀色 / CHROME



TZ- 002
黑色 / BLACK



TZ- 003
枪灰色 / GUN GRAY



TZ- 004
金色 / COLD



TZ- 011
电镀色 / CHROME



TZ- 012
黑色 / BLACK



TZ- 013
枪灰色 / GUN GRAY



TZ- 014
金色 / COLD



TZ- 017
拉丝色 / COLD





QE PB- 002
黑色 / BLACK



QE PB- 003
枪灰色 / GUN GRAY



QE PB- 004
白色 / WHITE



QE PB- 005
金色 / GOLD



QE PB- 021
黑银色 / BLACK SILVER



QE PB- 025
黑金色 / BLACK GOLD



QE PB- 041
白银色 / WHITE SILVER



QE PB- 045
白金色 / PLATINUM

面盆龙头系列
Basin faucet series



QD- 001
电镀色 / CHROME



QD- 002
黑色 / BLACK



QD- 003
枪灰色 / GUN GRAY



QD- 004
白色 / WHITE



QD- 005
金色 / GOLD

乔丹系列 Jordan series

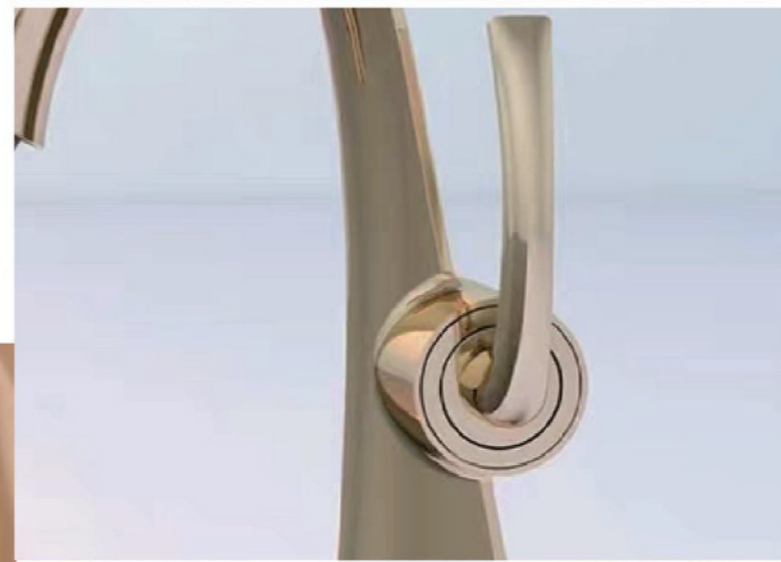



ZY- 001
电镀色 / CHROME



ZY- 003
枪灰色 / GUN GRAY



ZY- 005
金色 / GOLD

状元系列 Top Scholar Series





XTE- 001
电镀色 / CHROME



XTE- 002
黑色 / BLACK



XTE- 003
金色 / GOLD



XTE- 004
玫瑰金色 / ROSE GOLD



XTE- 005
黑玫瑰金色 / BLACK ROSE GOLD



XTE- 006
白玫瑰金色 / WHITE ROSE GOLD

面盆龙头系列
Basin faucet series



PB- 001
电镀 / CHROME



PB- 002
黑色 / BLACK



PB- 003
枪灰色 / GUN GRAY



PB- 004
白色 / WHITE



PB- 005
金色 / GOLD



PB- 006
玫瑰金色 / ROSE GOLD



PB- 007
拉丝金 / BRUSHED GOLD



PB- 010
奶白色 / DARK GOLD

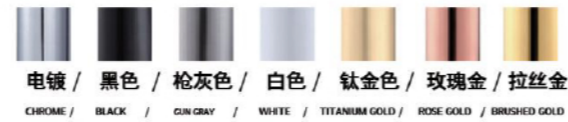
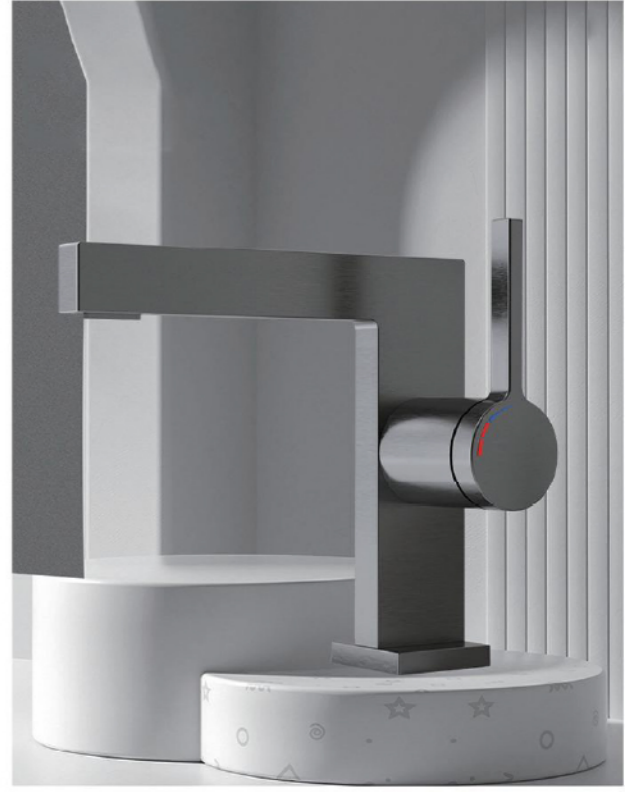

面盆龙头系列
Basin faucet series



SXJ- 001
电镀 / CHROME



SXJ- 002
黑色 / BLACK



SXJ- 003
枪灰色 / GUN GRAY



SXJ- 004
白色 / WHITE



SXJ- 005
金色 / GOLD

神仙居系列 Extension Xianju series

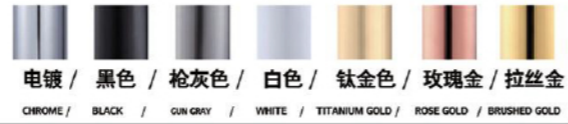



YW- 001
电镀 / CHROME



YW- 002
黑色 / BLACK



YW- 003
枪灰色 / GUN GRAY



YW- 004
白色 / WHITE

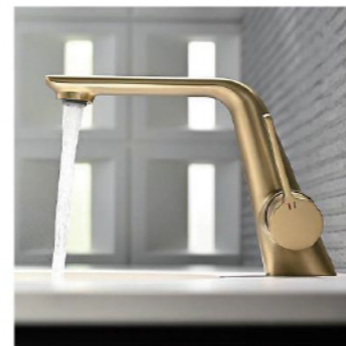

YW- 005
金色 / GOLD

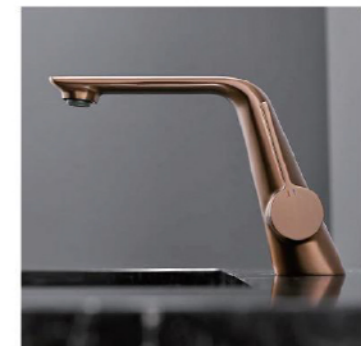

YW- 006
玫瑰金 / ROSE GOLD



面盆龙头系列
Basin faucet series



DCR- 001
电镀色 / CHROME



DCR- 002
黑色 / BLACK



DCR- 003
枪灰色 / GUN GRAY



DCR- 004
白色 / BLACK



DCR- 005
金色 / GUN GRAY



DCR- 029
黑红色 / BLACK RED



DCR- 011
电镀色 / CHROME



DCR- 012
黑色 / BLACK



DCR- 013
枪灰色 / GUN GRAY



DCR- 014
白色 / BLACK



DCR- 015
金色 / GUN GRAY



DCR- 129
黑红色 / BLACK RED

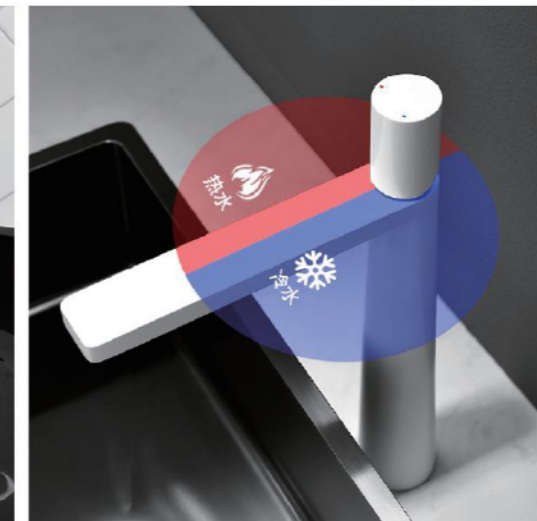
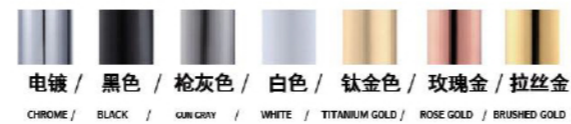

面盆龙头系列
Basin faucet series



FK- 001
电镀色 / CHROME



FK- 002
黑色 / BLACK



FK- 003
枪灰色 / GUN GRAY



FK- 004
白色 / WHITE



FK- 005
金色 / GOLD



FK- 029
黑红色 / BLACK RED



FK- 011
电镀色 / CHROME



FK- 012
黑色 / BLACK



FK- 013
枪灰色 / GUN GRAY



FK- 014
白色 / WHITE



FK- 015
金色 / GOLD



FK- 129
黑红色 / BLACK RED





PG- 001
电镀 / CHROME



PG- 002
黑色 / BLACK

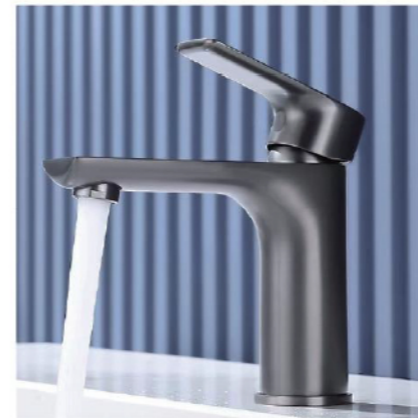

PG- 003
枪灰色 / GUN GRAY



PG- 004
白色 / WHITE



PG- 011
电镀 / CHROME



PG- 012
黑色 / BLACK



PG- 013
枪灰色 / GUN GRAY



PG- 014
白色 / WHITE





SF- 003
枪灰色 / GUN GRAY



SF- 011
电镀色 / CHROME



SF- 016
玫瑰金 / ROSE GOLD

四方系列 Tetragonal series

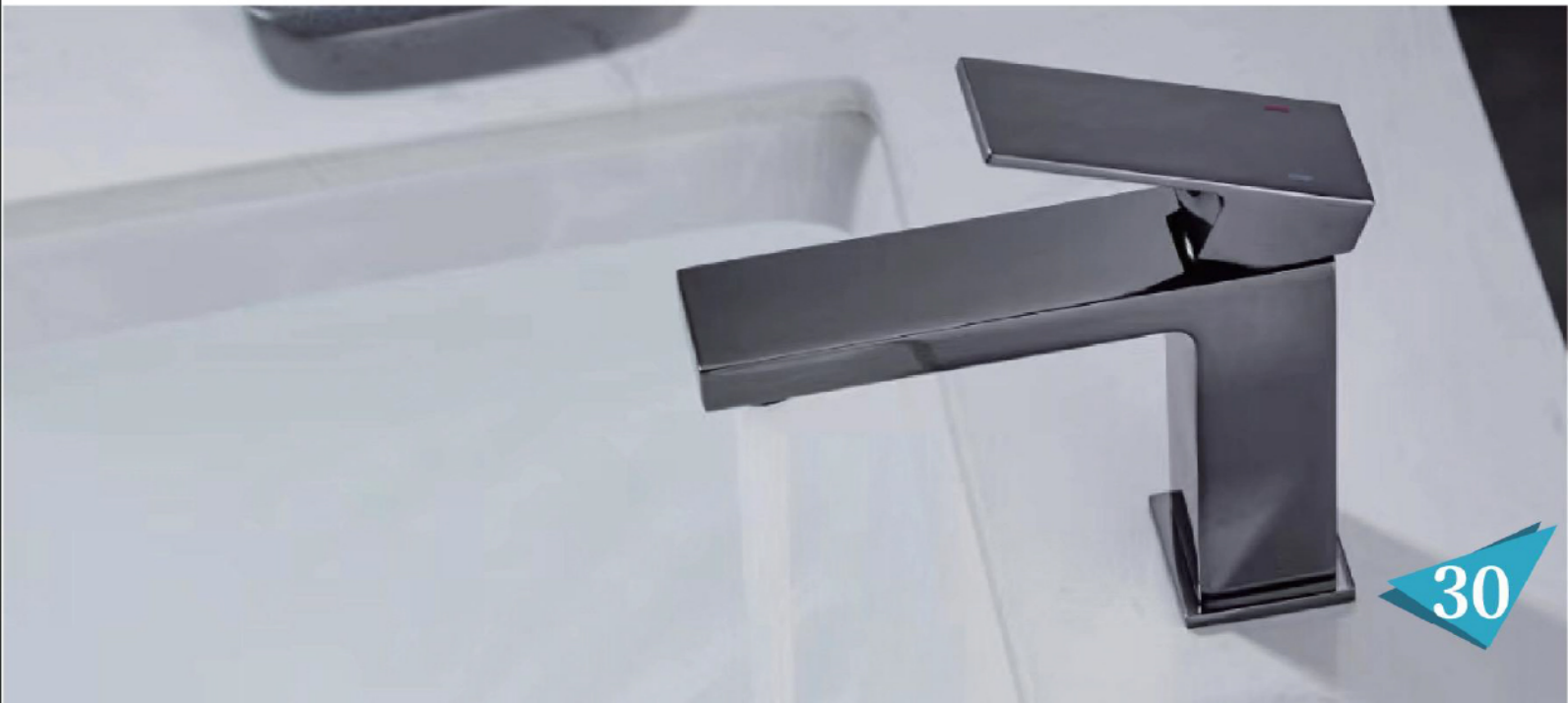
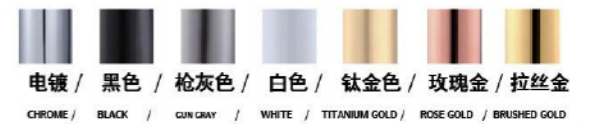



TD- 001
电镀 / CHROM



TD- 002
黑色 / BLACK



TD- 003
枪灰色 / GON GRAY



TD- 005
金色 / GOLD

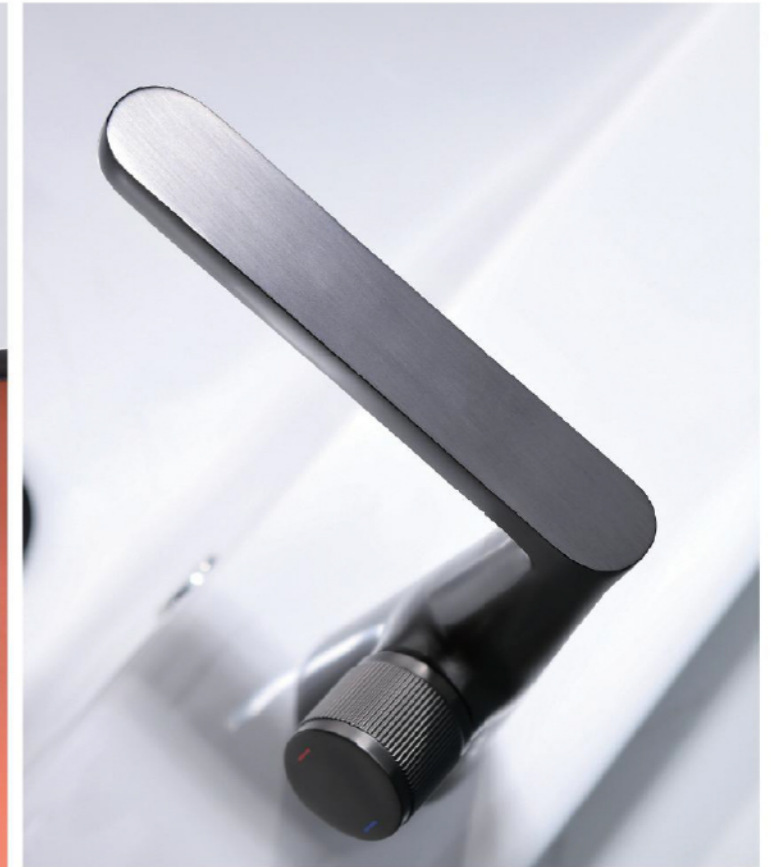



JL- 001
电镀色 / CHROME



JL- 002
黑色 / BLACK



JL- 003
枪灰色 / GUN GRAY

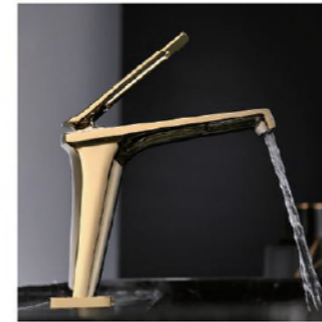

JL- 005
金色 / WHITE GOLD



JL- 025
黑金色 / DARK GOLD



JL- 029
黑红色 / BLACK RED



JL- 045
白金色 / WHITE GOLD



Double-heat, dual-control and dual-key, one-key switch between bubble water and sprinker water, suitable for different scenarios. It can be pulled at will, flexible and universal.



吉利系列 Geely series

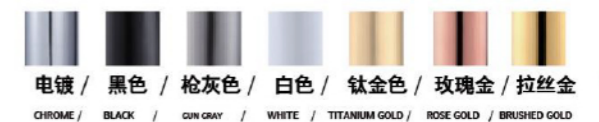



TG- 001
电镀色 / CHROME



TG- 002
黑色 / BLACK



TG- 003
枪灰色 / GUN GRAY



TG- 004
白色 / WHITE



TG- 005
金色 / GOLD



TG- 029
红帽黑色 / BLACK RED HAT



TG- 011
电镀色 / CHROME



TG- 012
黑色 / BLACK



TG- 013
枪灰色 / GUN GRAY



TG- 014
白色 / WHITE



TG- 015
金色 / GOLD



TG- 129
红帽黑色 / BLACK RED HAT

面盆龙头系列
Basin faucet series



JGRY- 011
电镀 / CHROME



JGRY- 012
黑色 / BLACK



JGRY- 018
拉丝色 / BRUSHED NICKEL



JGRY- 021
黑银色 / BLACK SILVER



JGRY- 125
黑金色 / DARK GOLD



JGRY- 145
白金色 / WHITE GOLD

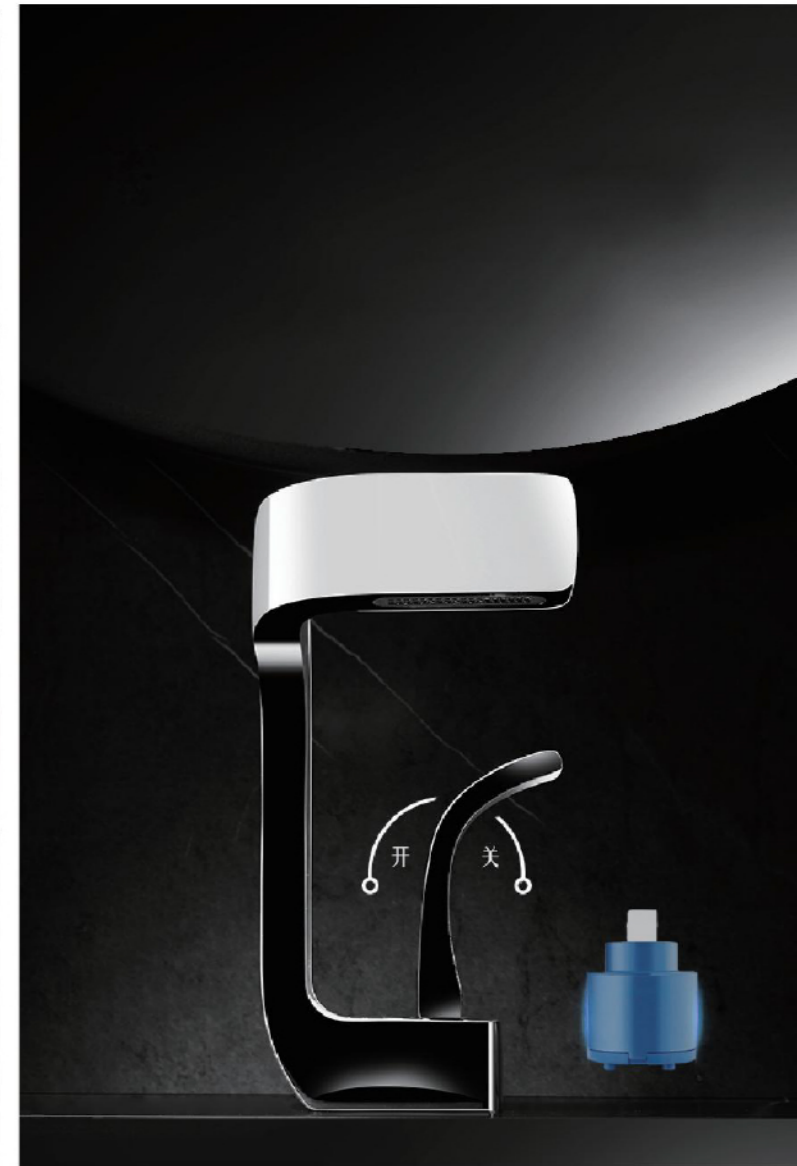

面盆龙头系列
Basin faucet series



YG- 001
电镀 / CHROM



YG- 014
白银色 / WHITE SILVER



YG- 011
电镀 / CHROM



YG- 114
白银色 / WHITE SILVER

遥感系列 Remote sensing series

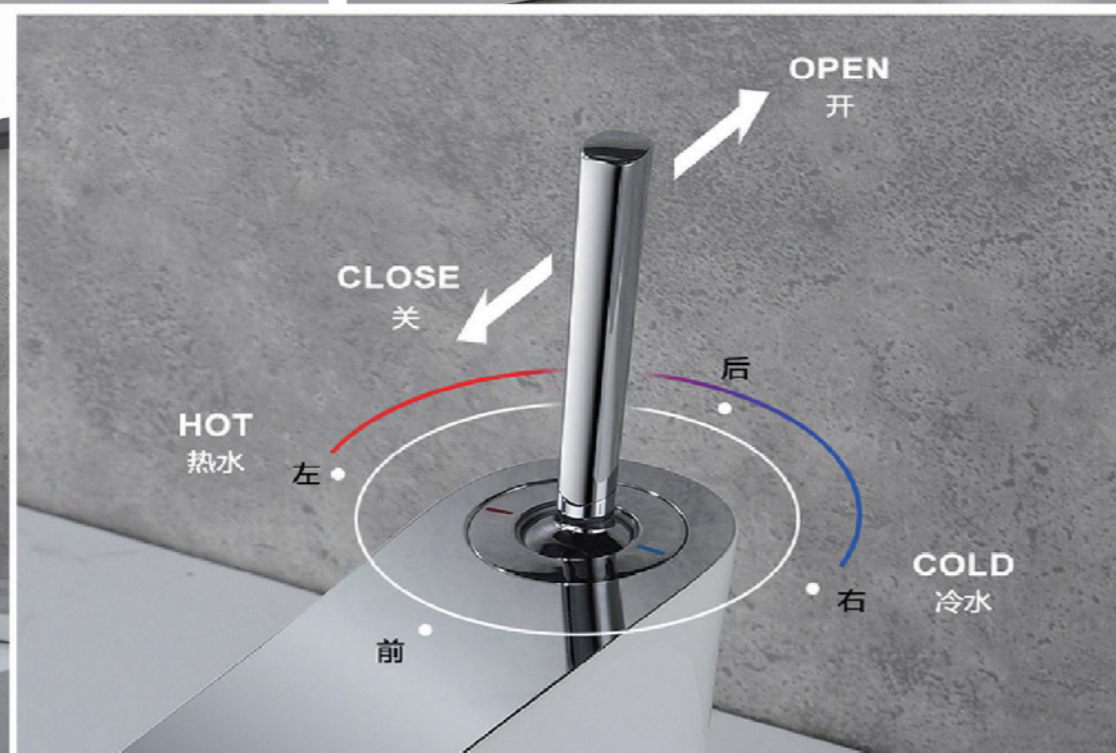
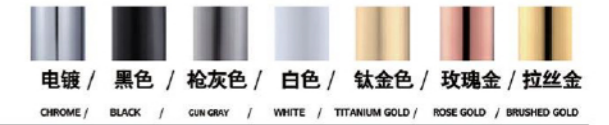

面盆龙头系列
Basin faucet series



WZSB- 001
电镀色 / CHROME



WZSB- 002
黑色 / BLACK



WZSB- 003
枪灰色 / GUN GRAY

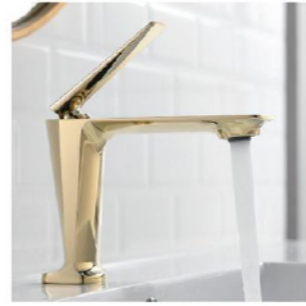

WZSB- 005
金色 / GOLD



WZ- 045
白金色 / WHITE GOLD



WZ- 145
白金色 / WHITE GOLD



WZSB- 006
玫瑰金 / ROSE GOLD

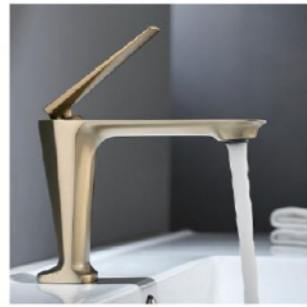

WZSB- 008
拉丝金 / BRUSHED GOLD



WZSB- 026
黑玫瑰金 / BLACK ROSE GOLD



WZSB- 025
黑金色 / DARK GOLD



WZSB- 011
电镀色 / CHROME



WZSB- 012
黑色 / BLACK

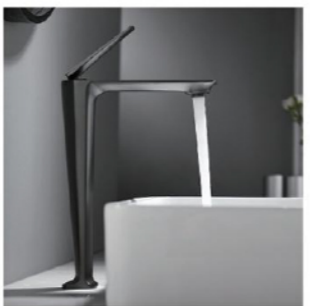

WZSB- 013
枪灰色 / GUN GRAY



WZSB- 015
金色 / GOLD



WZSB- 016
玫瑰金 / ROSE GOLD



WZSB- 018
拉丝金 / BRUSHED GOLD



WZSB- 125
黑金色 / DARK GOLD

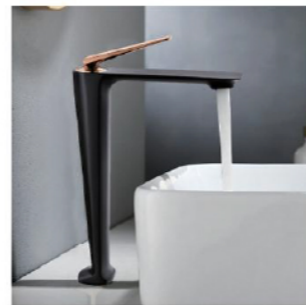

WZSB- 126
黑玫瑰金 / BLACK ROSE GOLD



面盆龙头系列
Basin faucet series



YD- 001
电镀色 / CHROME



YD- 002
黑色 / BLACK



YD- 025
黑金色 / DARK GOLD



YD- 045
白金色 / WHITE GOLD



YD- 011
电镀色 / CHROME



YD- 012
黑色 / BLACK



YD- 125
黑金色 / DARK GOLD



YD- 145
白金色 / WHITE GOLD

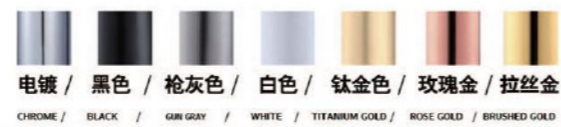



YZC- 001
电镀 / CHROM



YZC- 002
黑色 / BLACK



YZC- 003
枪灰色 / GON GRAY



YZC- 004
白色 / WHITE



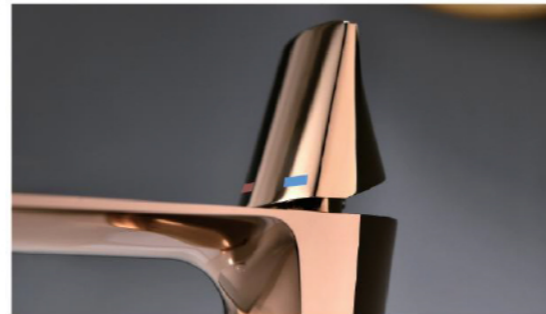

WZMZ- 001
电镀 / CHROME



WZMZ- 002
黑色 / BLACK



WZMZ- 003
枪灰色 / GUN GRAY



WZMZ- 008
拉丝金 / BRUSHED GOLD



WZMZ- 065
玫瑰金 / ROSE GOLD



WZMZ- 011
电镀 / CHROME

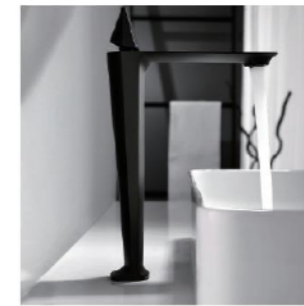

WZMZ- 012
黑色 / BLACK



WZMZ- 013
枪灰色 / GUN GRAY



WZMZ- 018
拉丝金 / BRUSHED GOLD



WZMZ- 165
玫瑰金 / ROSE GOLD





KS- 001
电镀 / CHROM

KS- 002
黑色 / BLACK



KS- 003
枪灰色 / GON GRAY

KS- 005
金色 / GOLD

面盆龙头系列
Basin faucet series



YYW- 001
电镀 / CHROME



YYW- 002
黑色 / BLACK



YYW- 003
枪灰色 / GUN GRAY



YYW- 004
白色 / WHITE



YYW- 025
黑金色 / DARK GOLD



YYW- 045
白金色 / WHITE GOLD



JD- 001
电镀 / CHROME



JD- 002
黑色 / BLACK



JD- 003
白色 / WHITE



JD- 005
金色 / GOLD



JD- 011
电镀 / CHROME



JD- 012
黑色 / BLACK



JD- 013
白色 / WHITE



JD- 015
金色 / GOLD

金刀系列 Golden Knife series

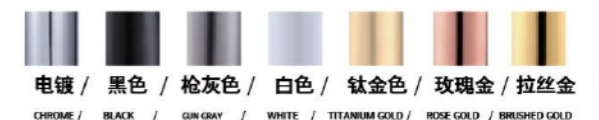

面盆龙头系列
Basin faucet series



CXY- 002
黑色 / BLACK



CXY- 003
枪灰色 / GUN GRAY



CXY- 005
金色 / GOLD



CXY- 014
白银色 / WHITE SILVER



CXY- 025
黑金色 / DARK GOLD

丑小鸭系列 Ugly Duckling series

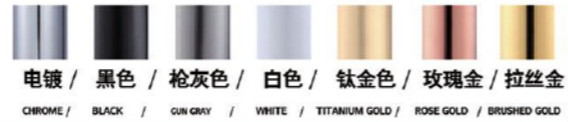



MG- 001
电镀色 / CHROME



MG- 002
黑色 / BLACK



MG- 005
金色 / GOLD



MG- 014
白银色 / WHITE SILVER



MG- 045
白金色 / WHITE GOLD

蘑菇系列 Mushroom series

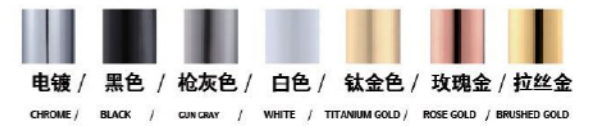



TD- 001
电镀 / CHROME

TD- 002
黑色 / BLACK

TD- 003
灰色 / GUN GRAY

太子系列 Prince series

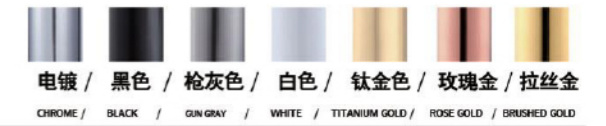



BKHM- 001
电镀 / CHROM



BKHM- 005
金色 / GOLD



BKHM- 014
白银色 / WHITE SILVER



BKHM- 021
黑银色 / BLACK SILVER

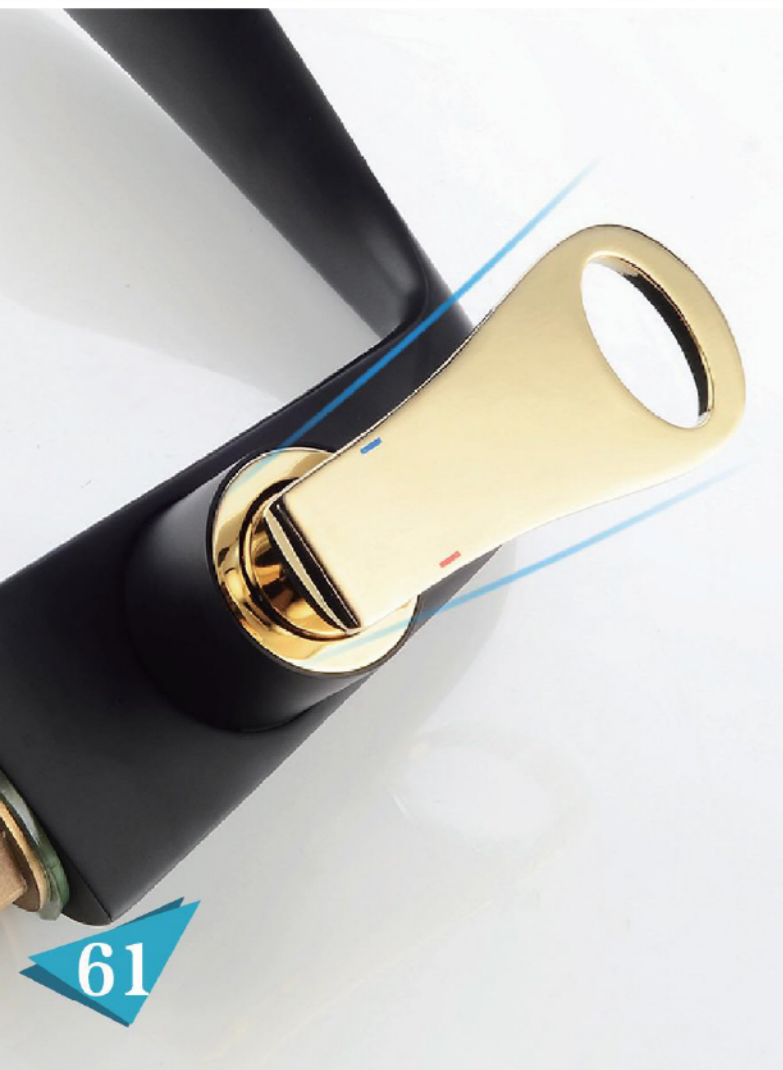

BKHM- 025
黑金色 / DARK GOLD



BKHM- 045
白金色 / WHITE GOLD



面盆龙头系列
Basin faucet series



BKDW- 001
电镀 / CHROM



BKDW- 025
黑金色 / DARK GOLD



BKDW- 045
白金色 / WHITE GOLD

边开大湾 Edge open big bay

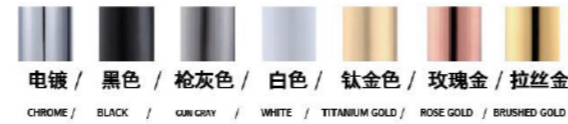

63



64



LSW- 002
黑色 / BLACK



LSW- 003
枪灰色 / GUN GRAY



LSW- 004
白色 / WHITE



LSW- 005
金色 / GOLD

面盆龙头系列
Basin faucet series



ZD- 001
电镀色 / CHROME

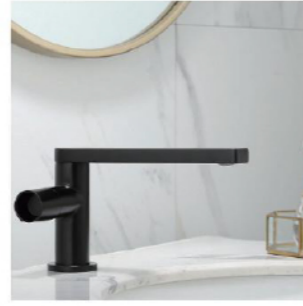

ZD- 002
黑色 / BLACK



ZD- 004
白色 / WHITE



ZD- 005
金色 / GOLD



ZD- 008
拉丝金色 / BRUSHED GOLD



ZD- 011
电镀色 / CHROME

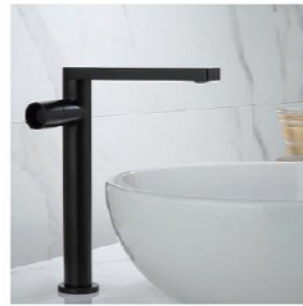

ZD- 012
黑色 / BLACK



ZD- 014
白色 / WHITE

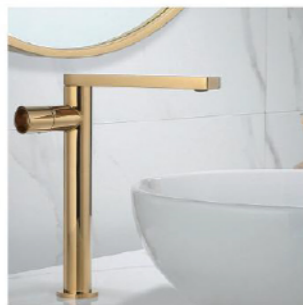

ZD- 015
金色 / GOLD



ZD- 018
拉丝金色 / BRUSHED GOLD

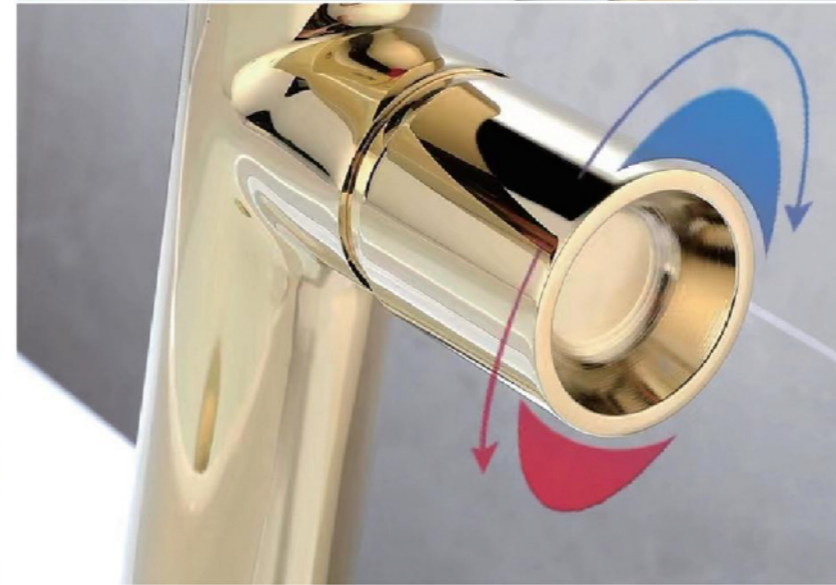



HD- 001
电镀色 / CHROME



HD- 002
黑色 / BLACK



HD- 003
枪灰色 / GUN GRAY



HD- 004
白色 / WHITE



HD- 025
黑金色 / DARK GOLD



HD- 045
白金色 / WHITE GOLD



HD- 011
电镀色 / CHROME



HD- 012
黑色 / BLACK



HD- 013
枪灰色 / GUN GRAY



HD- 014
白色 / WHITE



HD- 125
黑金色 / DARK GOLD

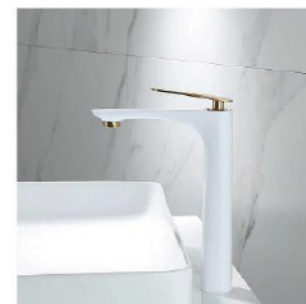

HD- 145
白金色 / WHITE GOLD

面盆龙头系列
Basin faucet series



BL- 001
电镀 / CHROM



BL- 002
黑色 / BLACK



BL- 014
白银色 / WHITE SILVER

波浪系列 Wave series

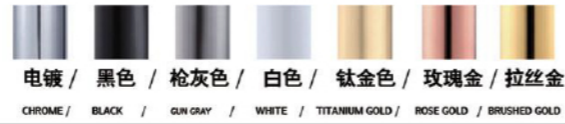



CE- 002
黑色 / BLACK



CE- 003
枪灰色 / GUN GRAY



CE- 005
金色 / GOLD



CE- 025
黑金色 / DARK GOLD



CE- 045
白金色 / WHITE GOLD



CE- 012
黑色 / BLACK



CE- 013
枪灰色 / GUN GRAY



CE- 015
金色 / GOLD

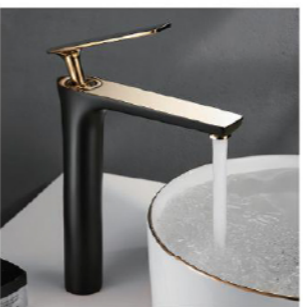

CE- 125
黑金色 / DARK GOLD



CE- 145
白金色 / WHITE GOLD



面盆龙头系列
Basin faucet series



MY- 001
电镀 / CHROME



MY- 002
黑色 / BLACK



MY- 004
银色 / WHITE SILVER



MY- 025
黑金色 / DARK GOLD



MY- 045
白金色 / WHITE GOLD



MY- 011
电镀 / CHROME



MY- 012
黑色 / BLACK



MY- 014
银色 / WHITE SILVER



MY- 125
黑金色 / DARK GOLD

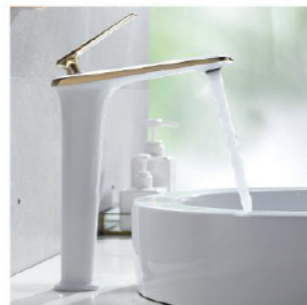

MY- 145
白金色 / WHITE GOLD

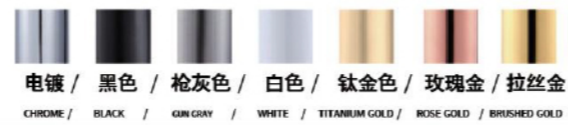



SERIES
TIANLU

天路系列 Tianlu series

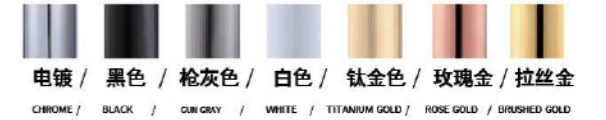

TL- 001
电镀 / CHROME

透过舒适简约的设计、环保健康的选材、华丽的色彩来倾诉着典雅、独具一格的风格诠释美学的格调。
Through comfortable and minimalist design, environmentally friendly and healthy material selection, and gorgeous colors, we express elegance and interpret the aesthetic style with a unique style.



TL- 002
黑色 / BLACK



TE- 001
电镀 / CHROME



TE- 002
黑色 / BLACK



TE- 003
枪灰色 / GUN GRAY



TE- 061
铬金色 / CHROME GOLD





SERIES
TIANLIU



FDJ- 001
电镀 / CHROME

放大镜系列 Magnifying glass series

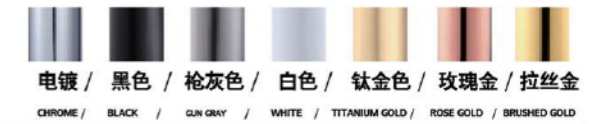

FDJ- 002
黑色 / BLACK

透过舒适简约的设计、环保健康的选材、华丽的色彩来倾诉着典雅、独具一格风格诠释美学的格调。
Through comfortable and minimalist design, environmentally friendly and healthy material selection, and gorgeous colors, we express elegance and interpret the aesthetic style with a unique style.



FDJ- 005
金色 / GOLD



JT- 001
电镀 / CHROME



JT- 002
黑色 / BLACK



JT- 011
电镀 / CHROME

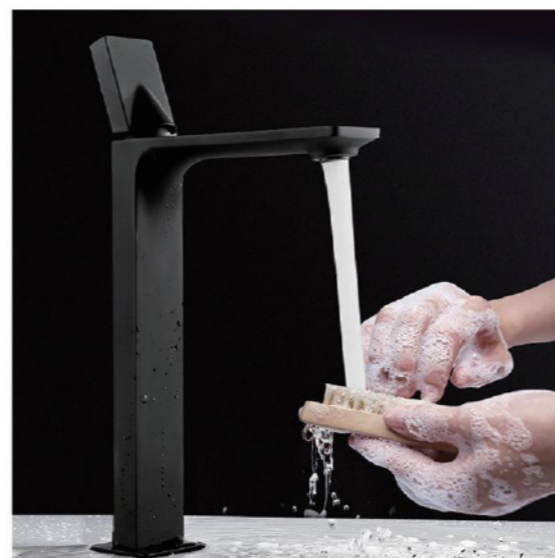

JT- 012
黑色 / BLACK





DJS- 001
电镀 / CHROME



DJS- 002
黑色 / BLACK



DJS- 005
金色 / GOLD



DJS- 014
白银色 / WHITE SILVER



DJS- 026
黑玫瑰金色/BLACK ROSE GOLD



DJS- 045
白金色 / WHITE GOLD





XT- 001
电镀 / CHROME



XT- 002
黑色 / BLACK

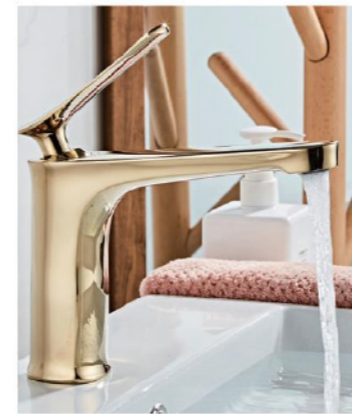

XT- 005
金色 / GOLD



XT- 014
白银色 / WHITE SILVER

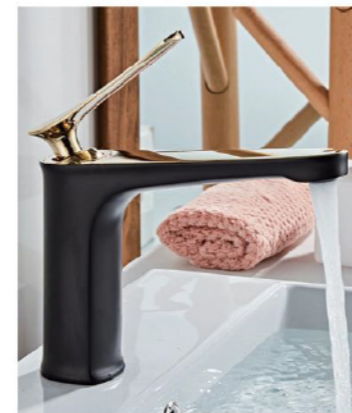

XT- 025
黑金色 / DARK GOLD



XT- 045
白金色 / WHITE GOLD

面盆龙头系列
Basin faucet series



WHDW- 002
黑色 / BLACK



WHDW- 003
枪灰色 / GUN GRAY



WHDW- 004
白色 / WHITE

网红大湾系列 Network red Big Bay series

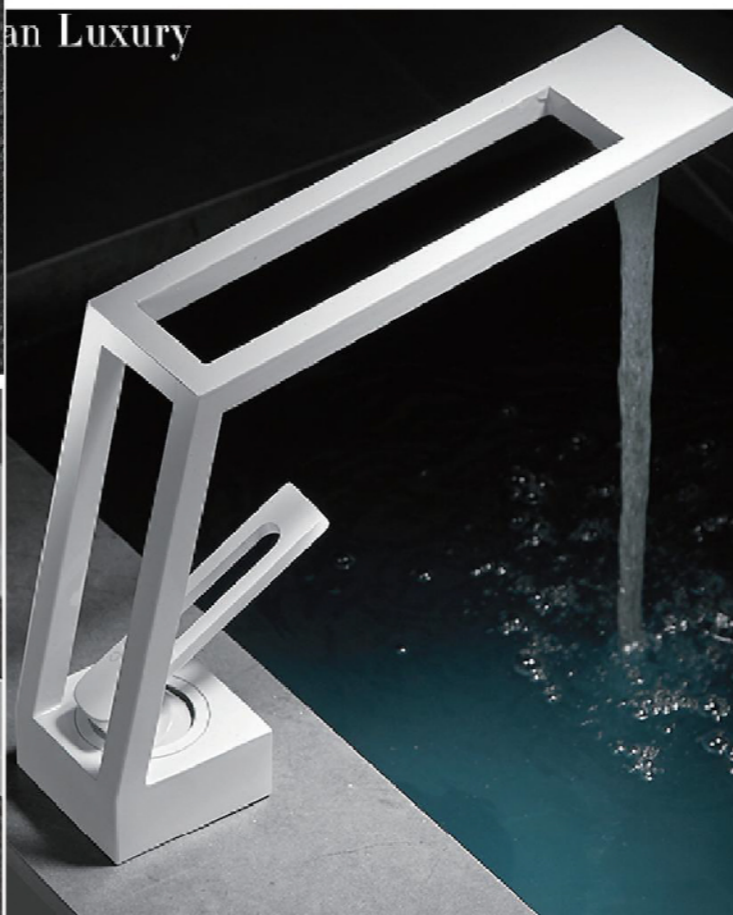
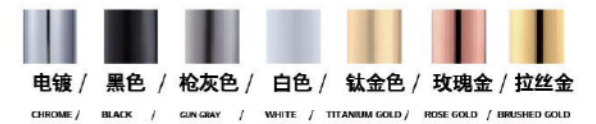

SERIES
TIANLIU



牛角系列 Horn series

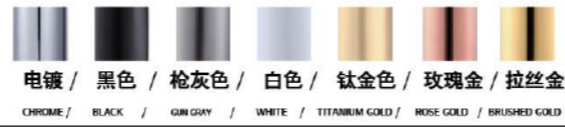

NJ- 001
电镀 / CHROME

透过舒适简约的设计、环保健康的选材、华丽的色彩来倾诉着典雅，独具一格风格诠释美学的格调。
Through comfortable and minimalist design, environmentally friendly and healthy material selection, and gorgeous colors, we express elegance and interpret the aesthetic style with a unique style.

NJ- 005
金色 / GOLD





ZSPB- 045
白金色 / WHITE GOLD

钻石瀑布系列 Masonry waterfall series

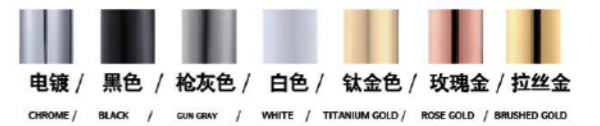



XY- 001
电镀 / CHROME



XY- 002
黑色 / BLACK



XY- 025
黑金色 / DARK GOLD



XY- 045
白金色 / WHITE GOLD

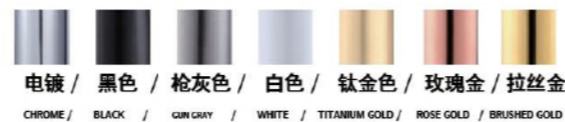



YZ- 001
电镀色 / CHROME



YZ- 002
黑色 / BLACK



YZ- 003
枪灰色 / GUN GRAY



YZ- 004
白色 / WHITE



YZ- 005
金色 / GOLD



YZ- 006
玫瑰金色 / GOLD



YZ- 011
电镀色 / CHROME



YZ- 012
黑色 / BLACK



YZ- 013
枪灰色 / GUN GRAY



YZ- 014
白色 / WHITE



YZ- 015
金色 / GOLD



YZ- 016
玫瑰金色 / GOLD

面盆龙头系列
Basin faucet series



RY- 001
电镀 / CHROME



RY- 002
黑色 / BLACK



RY- 003
灰色 / GUN GRAY



RY- 005
金色 / GOLD



RY- 006
玫瑰金色 / ROSE GOLD



RY- 007
拉丝金色 / BRUSHED GOLD



RY- 008
拉丝色 / BRUSHED NICKEL



RY- 025
黑金色 / DARK GOLD





DF- 001
电镀色 / CHROME

DF- 002
黑色 / BLACK

DF- 003
枪灰色 / GUN GRAY

DF- 004
白色 / WHITE



DF- 005
金色 / GOLD



DF- 006
玫瑰金色 / ROSE GOLD



DF- 025
黑金色 / DARK GOLD



DF- 045
白金色 / GUN GRAY



DF- 011
电镀色 / CHROME



DF- 012
黑色 / BLACK



DF- 013
枪灰色 / GUN GRAY



DF- 014
白色 / WHITE



DF- 015
金色 / GOLD



DF- 016
玫瑰金色 / ROSE GOLD



DF- 125
黑金色 / DARK GOLD



DF- 145
白金色 / GUN GRAY

面盆龙头系列
Basin faucet series



YLW- 001
电镀 / CHROME



YLW- 002
黑色 / BLACK



YLW- 003
枪灰色 / GUN GRAY



YLW- 004
白色 / WHITE



YLW- 005
金色 / GOLD



YLW- 006
玫瑰金色 / ROSE GOLD



YLW- 007
拉丝金 / BRUSHED GOLD



YLW- 025
黑金色 / DARK GOLD



YLW- 045
白金色 / WHITE GOLD





CJL- 001
电镀 / CHROME

CJL- 002
黑色 / BLACK



CJL- 003
枪灰色 / GUN GRAY

CJL- 005
金色 / GOLD



MD- 001
电镀 / CHROME



MD- 002
黑色 / BLACK



MD- 003
枪灰色 / GUN GRAY



MD- 005
金色 / GOLD

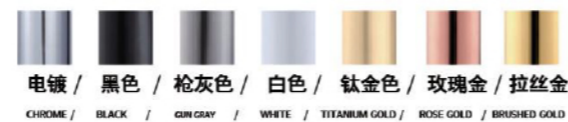
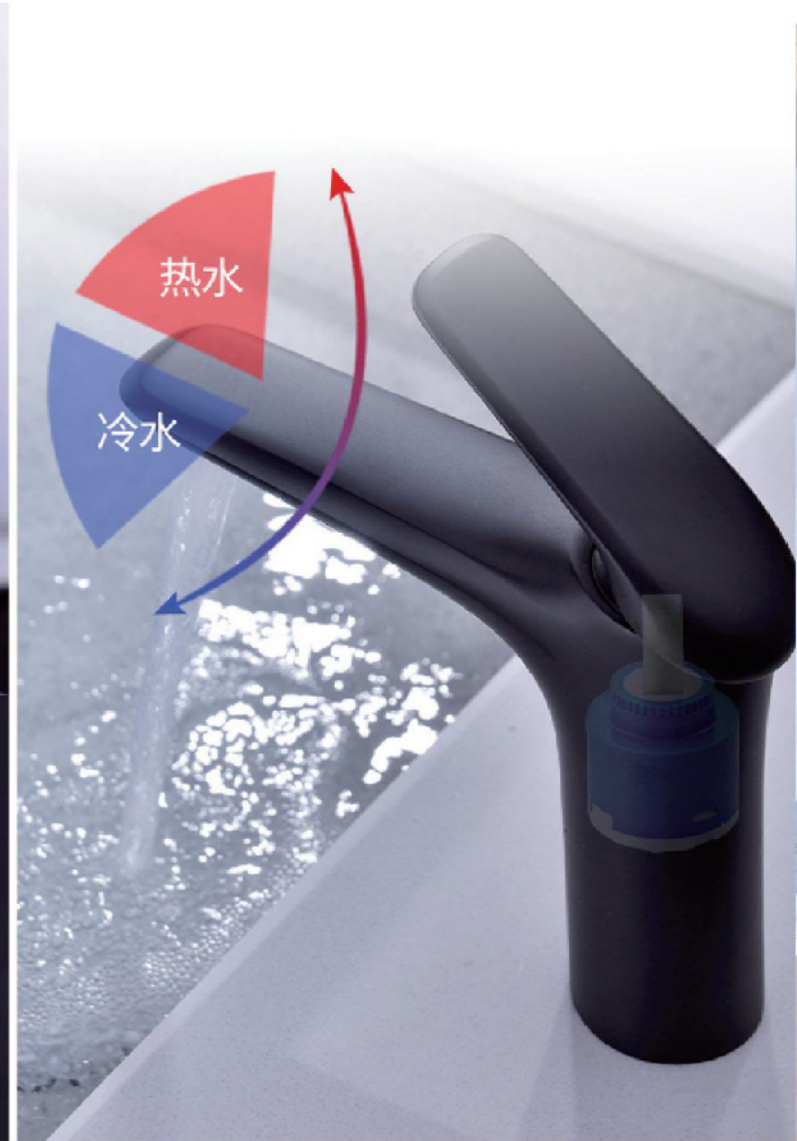



HT/HCT- 002
黑色 / BLACK



HT/HCT- 014
白银色 / WHITE SILVER



HT/HCT- 025
黑金色 / DARK GOLD



HT/HCT- 045
白金色 / WHITE GOLD



HT/HCT- 012
黑色 / BLACK



HT/HCT- 114
白银色 / WHITE SILVER



HT/HCT- 125
黑金色 / DARK GOLD



HT/HCT- 145
白金色 / WHITE GOLD



HM- 001
电镀色 / CHROME

HM- 021
黑银色 / BLACK SILVER

HM- 045
白金色 / WHITE GOLD

海马系列 Hippocampus series

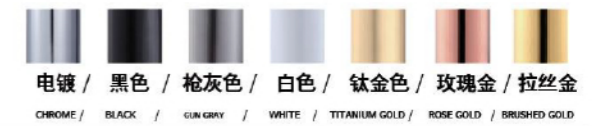

面盆龙头系列
Basin faucet series



HCTPB- 001
电镀色 / CHROME



HCTPB- 002
黑色 / BLACK



HCTPB- 005
金色 / GOLD



HCTPB- 014
白银色 / WHITE SILVER



HCTPB- 025
黑金色 / BLACK SILVER



HCTPB- 045
白金色 / WHITE GOLD



HCTPB- 011
电镀色 / CHROME



HCTPB- 012
黑色 / BLACK



HCTPB- 015
金色 / GOLD



HCTPB- 114
白银色 / WHITE SILVER



HCTPB- 125
黑金色 / BLACK SILVER



HCTPB- 145
白金色 / WHITE GOLD



面盆龙头系列
Basin faucet series



HCTPB- 001
电镀色 / CHROME



HCTPB- 002
黑色 / BLACK



HCTPB- 005
金色 / GOLD



HCTPB- 014
白银色 / WHITE SILVER



HCTPB- 025
黑金色 / BLACK SILVER



HCTPB- 045
白金色 / WHITE GOLD



HCTPB- 011
电镀色 / CHROME



HCTPB- 012
黑色 / BLACK



HCTPB- 015
金色 / GOLD



HCTPB- 114
白银色 / WHITE SILVER



HCTPB- 125
黑金色 / BLACK SILVER



HCTPB- 145
白金色 / WHITE GOLD

